

CUBE FLUX METHOD TO GENERATE SPACECRAFT THERMAL ENVIRONMENTS

Siraj A. Jalali, Ph.D., P.E.
Oceaneering Space Systems

ABSTRACT

Spacecrafts are exposed to various environments that are not present at the surface of the earth, like plasmas, neutral gases, x-rays, ultraviolet (UV) irradiation, high energy charged particles, meteoroids, and orbital debris. The interaction of these environments with spacecraft cause degradation of materials, contamination, spacecraft glow, charging, thermal changes, excitation, radiation damage, and induced background interference. The damaging effects of natural space and atmospheric environments pose difficult challenges for spacecraft designers. ISS/Shuttle thermal model was used to develop a program to determine environment around an orbiting spacecraft. The method was applied to compare environments around the ISS/Shuttle in Earth and Mars orbits. The method was also applied on a Satellite in Lower Earth Orbit (LEO) and Geosynchronous Orbit (GEO) and results were compared.

To determine the thermal environments around the ISS/Shuttle 1 cubic foot arithmetic cubes were placed 1 foot above the surfaces where thermal environments were needed. The ISS/Shuttle was placed in Earth and Mars orbits with same beta, attitudes, and altitude. The hot case winter solstice Solar, Albedo, and IR fluxes were applied on the integrated model. The model was analyzed such that absorbed solar fluxes and surface temperatures of all cube surfaces were obtained. A routine (**HTFLXCAL**) was developed to calculate Infrared fluxes for all cube surfaces using solar fluxes absorbed by the cube and its surface temperatures. The solar and infrared fluxes at a cube location were used to calculate orbital sink temperatures at that location. The sink temperatures at a cube location are extreme temperatures an ORU, EVA tool, spacecraft surfaces, or space suit will be exposed to at that location.

The cube flux method has been previously developed by Lockheed Martin; similar principle of flux generation has been adopted in this study. The method presented here is efficient and simple since the orbiter model and flux generation routine (**HTFLXCAL**) are run from Thermal Desktop® in a single run, and Solar and IR fluxes for all cube locations are generated, and the sink temperatures for given optical properties are also produced. The sink temperatures calculation routine for required materials using Solar and IR fluxes is part of the HTFLXCAL.

1.0 INTRODUCTION

Thermal environments were determined around ISS/Shuttle in Earth and Mars orbits and also around a Satellite in LEO and GEO. Sink temperatures for different materials were calculated using generated

solar and IR fluxes and those sink temperatures were compared for Earth and Mars as well as LEO and GEO. In this study environment generation method will be explained using ISS/Shuttle while orbiting the Earth.

The flux generation method used A Thermal Desktop® ISS model with eleven (11) cubes placed at different locations to determine solar and IR fluxes at those locations. Orbital conditions were considered as hot winter solstice. ISS/Shuttle orbital cycle around the Earth was divided into 48 segments. First phase of analysis produced combined solar and Albedo fluxes along with cube surface temperatures. In second phase a SINDA routine (HTFLXCAL) determined solar and IR fluxes at given cube locations. In third phase sink temperatures were determined at cube locations for applied optical conditions. The method was also applied to determine ISS/Shuttle environments while orbiting the Mars. The Earth and Mars environments were compared to show the difference in Earth and Mars orbital environments. The program developed can be used for designing spacecrafts and planning space missions.

2.0 DISCUSSION

Before discussing the methodology of the cube flux generation, the rationale for assuming Earth solar and IR energies are discussed as well as theory behind using flux cube method are laid out.

The basis for using Earth solar and IR fluxes are emerging from the solar flux emanating from Sun's surface. The Sun rate of emission reaching the Earth surfaces is used to calculate Q_{sol} and Q_{ir} .

Sun's rate of emission from the photosphere:

By applying Stefan-Boltzmann Law:

$$I = \sigma \cdot T^4 \text{ (assuming emissivity} = 1.0) \tag{1}$$

Where I = energy flux, Watts/m²

$$\sigma = \text{Stefan-Boltzmann's constant} = 5.670373 \times 10^{-8} \text{ W/m}^2/\text{K}^4$$

$$T = \text{Sun photosphere temperature} = 6000 \text{ K (max)}$$

$$I = 7.349 \times 10^7 \text{ W/m}^2 \text{ (Energy flux from Sun)}$$

Total energy emitted by Sun's photosphere:

$$E_p = I \times PA \tag{2}$$

Where PA = Sun's photosphere surface area = $4 \cdot \pi \cdot r_p^2$

$r_p = 647 \times 10^6$ m (photosphere radius)

$E_p = 3.866 \times 10^{26}$ Watts

2.1 Earth Solar Flux (Qsol):

As the Sun radiates energy in all directions, we can think of it being spread out over the surface of sphere of ever increasing volume and surface area.

At the distance of Earth, the sphere will have a radius equal to Earth's average distance from the Sun (150×10^9 m). So Sun energy (W) will be spread over photosphere of radius $r_p = 150 \times 10^9$ m.

Energy received by Earth:

$$Q_{sol} = E_p / 4 \cdot \pi \cdot r_p^2 \quad (3)$$

$$Q_{sol} = E_p / 4 \cdot \pi \cdot (150 \times 10^9)^2 = \mathbf{1367.23 \text{ W/m}^2} = 433.41 \text{ BTU/hr.ft}^2 \sim \mathbf{434 \text{ Btu/hr.ft}^2}$$

This energy received by Earth is called Earth Solar Constant or **Earth Solar Flux** (Q_{sol})

2.2 Earth IR Flux (Qir):

The Solar Constant is not the energy that falls on a typical square meter of Earth. The Solar Constant is Sun's energy at right angle to the Earth, but Earth surfaces are set back at an angle, resulting in lower intensity. Total energy falling on an average Earth area:

$E = \text{Total Energy Intercepted} / \text{Surface Area of Earth}$

$E = \text{Solar Constant} \times \text{Area of Earth Disk} / \text{Surface Area of Earth}$

$$E = Q_{sol} \times (\pi \cdot r_e^2) / (4 \cdot \pi \cdot r_e^2)$$

$$E = Q_{sol} / 4 \quad (4)$$

$$E = 341.81 \text{ W/m}^2$$

Earth Planetary Albedo is estimated to be 30%, or 0.3. Therefore, the absorbed energy is 70%, or 0.7 times of incoming energy.

$$\text{Earth IR} = Q_{\text{ir}} = E \times 0.7 = 239.26 \text{ W/m}^2 = 75.85 \text{ Btu/hr.ft}^2 \sim \mathbf{76 \text{ Btu/hr.ft}^2}$$

2.3 Earth Energy Distribution

Solar energy when entering the Earth atmosphere is distributed in numerous ways. Some of the solar energy is absorbed by the Earth surface that warms up the surface and reflected to space as infrared energy. Some part of solar energy reflected off of planet diffused to space, that part of energy is called Albedo. General classification of the Earth global energy flows are shown in Figure 1 below [2]:

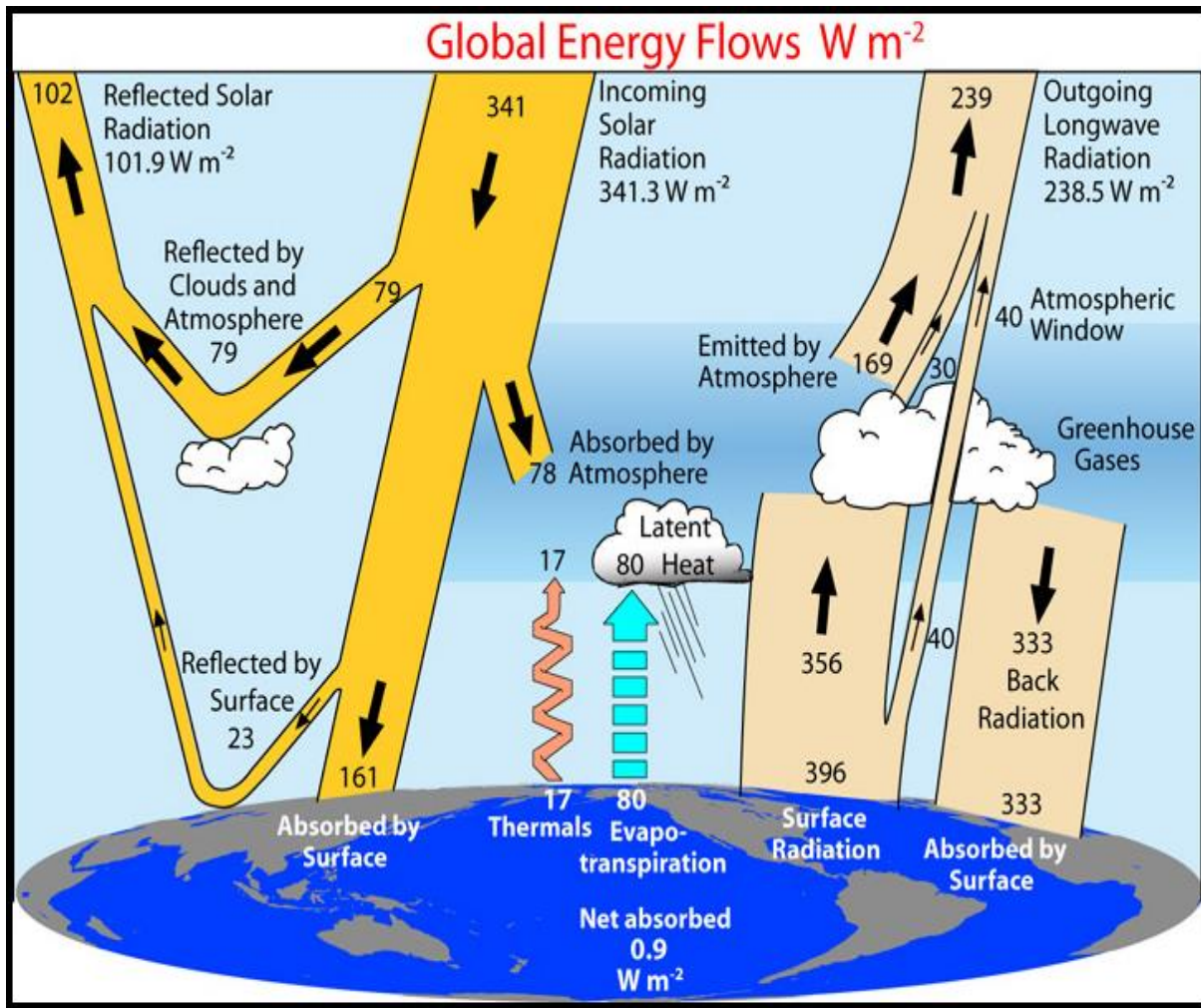

Figure 1. Earth global energy distribution.

Percentage-wise Solar radiation distributions are shown in Figure 2 [2], where 30% lost to space (Albedo) is shown along with energy absorbed by earth to be reflected out as Earth IR energy.

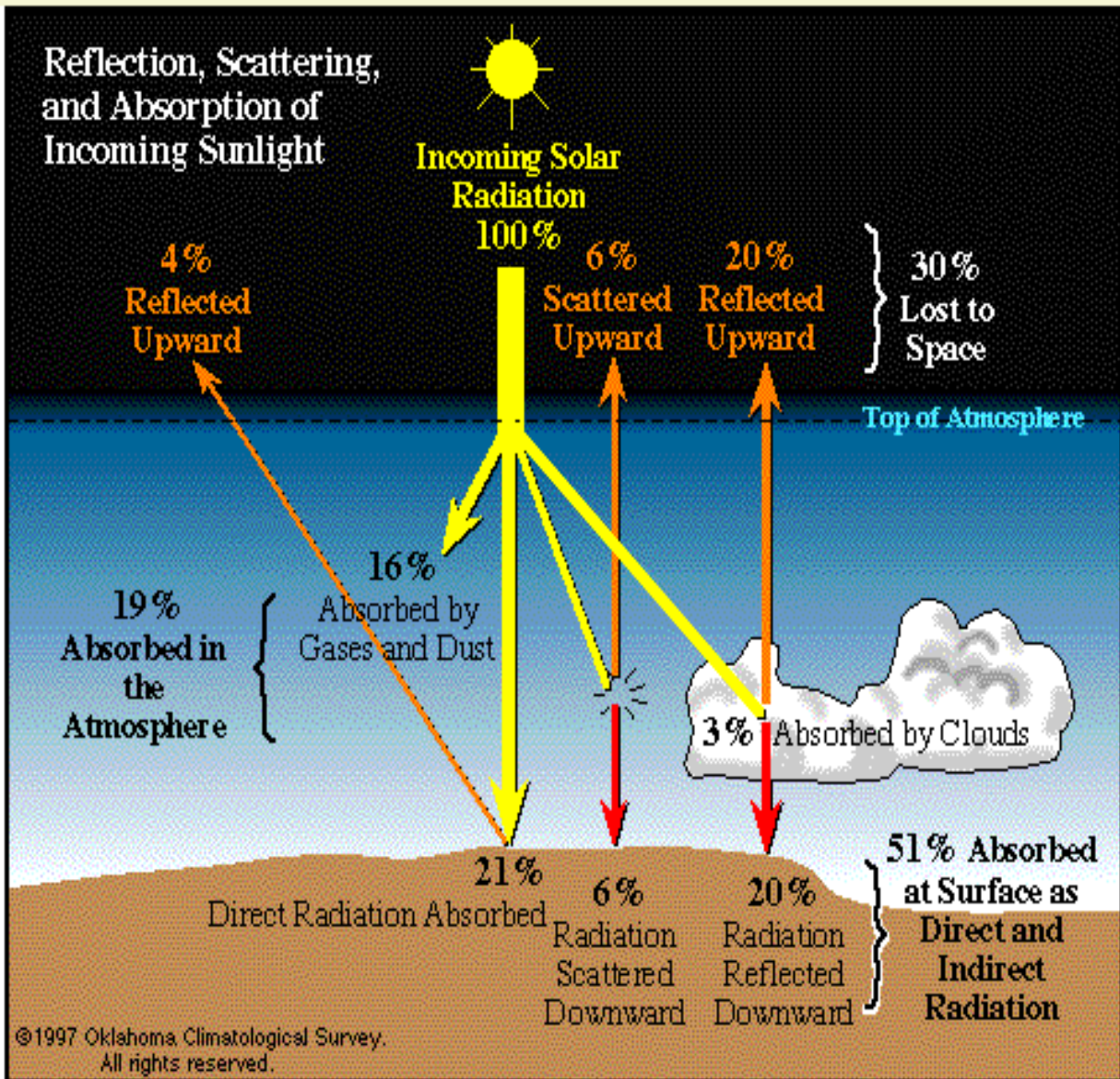

Figure 2. Percentage distribution of incoming solar radiation.

The environments on a Satellite or Station around the Earth are results of combine effects of Direct Solar, Albedo, and Planet Infrared energies distributions as shown in Figure 1 and 2 above.

3.0 Solar and Infrared Fluxes:

The rationale behind using 1 cubic ft (1x1x1) cube to determine environments over ISS/Orbiter is that energy received from all six directions are accounted for, plus for ease of accounting fluxes received by the cube surface will be per unit area. If total solar and IR fluxes at any location are known then given the optical properties of an ORU, tool, or spacesuit surface at that location, the sink temperatures for that surface can be calculated. The sink temperatures are the environment temperatures a surface will come to if that surface has no mass. By knowing the Q_{solar} and Q_{ir} at any location, the sink temperatures at that location a surface will expose to can be determined [6].

Total heat absorbed by a cube:

$$Q_{\text{absorbed}} = \alpha_{\text{solar}} \cdot Q_{\text{solar}} + \epsilon_{\text{ir}} \cdot Q_{\text{ir}} \quad (5)$$

- α_{solar} = Solar absorptivity of the material for which sink temperature is required
 $\alpha_{\text{solar}} = \epsilon_{\text{solar}}$ (over solar wavelengths or visible wavelengths)
- ϵ_{ir} = Infrared emissivity of the material for which sink temperature is required
 $\epsilon_{\text{ir}} = \alpha_{\text{ir}}$ (over infrared wavelengths)
- Q_{solar} = absorbed solar flux, comprised of following four parts:
 1. **Direct Solar** - incident onto the surface in question.
 2. **Reflected Solar** - direct solar reflected off of other ISS hardware surfaces to the surface in question.
 3. **Direct Albedo** - solar reflected off of planet diffused to space called Albedo to the surface in question.
 4. **Reflected Albedo** - Solar reflected off of planet and re-reflected off of ISS hardware surfaces onto the surface in question.

The above solar fluxes Q_{solar} (#1 to #4) are obtained by running the model in TD[®] (ISS/Shuttle model with cubes) and having Heatrate output comprised of Solar and Albedo as combined array for each surface. Also surface temperatures are calculated by SINDA in TD[®] and generated as an output array for all 6 surfaces of each cube. The above two files, one with Q_{solar} and other with temperatures for

each surface, are used as input to a SINDA routine (HTFLXCAL) to calculate the Infrared flux (Q_{ir}) for each cube. The HTFLXCAL calculates the total infrared thermal radiation incident on each surface of a cube individually through heat balance using the SINDA calculated cube surface temperatures and the TD[®] supplied incident solar fluxes. Assuming cube surfaces as adiabatic.

$$Q_{\text{absorbed}} = \alpha_{\text{sol}} \cdot Q_{\text{sol}} + \epsilon_{\text{ir}} \cdot Q_{\text{ir}}$$

$$\sigma \cdot \epsilon_{\text{ir}} \cdot (T_{\text{surface}}^4 - T_{\text{space}}^4) = \alpha_{\text{sol}} \cdot Q_{\text{sol}} + \epsilon_{\text{ir}} \cdot Q_{\text{ir}}$$

$$\text{for } T_{\text{space}} \approx 0 \text{ }^\circ\text{R}$$

$$Q_{\text{ir}} = \sigma \cdot T_{\text{surface}}^4 - (\alpha_{\text{sol}} / \epsilon_{\text{ir}}) \cdot Q_{\text{sol}}$$

Now using SINDA calculated surface temperatures (T_{surface}) and incident solar fluxes (Q_{sol}) the Q_{ir} can be backtracked. Cube surfaces are treated as blackbody so $\alpha_{\text{sol}} / \epsilon_{\text{ir}} = 1$

$$Q_{\text{ir}} = \sigma \cdot T_{\text{surface}}^4 - Q_{\text{sol}} \quad (6)$$

All combined Q_{sol} are provided as arrays by TD[®] when in 'Heatrate Output' tab 'Solar' and 'Albedo' are checked (selected). With RadK generated by TD[®] the cubes T_{surface} are calculated by SINDA. Using T_{surface} and Q_{sol} the HTFLXCAL calculates Q_{ir} of each cube. The Q_{ir} for each cube surface is calculated separately by using Equation (6) above and then average of all six (6) sides is calculated to get overall Q_{ir} at that cube location.

- The solar constant varies from 1322 W/m² (419.07 Btu/hr/ft²) (summer solstice when Sun is farthest on June 21st) to 1414 W/m² (448.24 Btu/hr/ft²) (winter solstice when Sun is closest on December 21st) over one Vernal Equinox period. Vernal Equinox is a point in space where sun would be on March 21st each year. For inertial attitudes, the stars are used as a reference point. The 0, 0, 0 pitch, yaw, roll correspond to:
 - +X (velocity vector) point at a point in space (Vernal Equinox) where sun would be on or about March 21 of each year (Sun moves = 1 degree/day)
 - +Z pointing at the North Star
 - Y axis parallel to Earth's equatorial plane.

- For TD[®] to calculate Q_{sol} the values normally used for planet Earth are 449 Btu/hr/ft² (1416.41 W/m²) for hot case analysis and 419 Btu/hr/ft² (1321.77 W/m²) for cold case analysis.
- TD[®] Albedo flux output is comprised of Direct Albedo and Reflected Albedo (3. and 4. above). Albedo is expressed in TD[®] as the percentage of incident solar which is diffusely reflected. Albedo may vary from 20% to 40% of the planetary incident solar diffused out to space depending upon the following:
 - Albedo is higher over continents than oceans
 - Albedo increases with cloud cover, snow, or ice
 - Albedo typically increases with latitude
 - With constant Albedo the energy reaching to a spacecraft decreases as it moves away from the subsolar point (noon). Earth directly under the sun receiving more flux and hence spacecraft when above that location is likely to receive more fluxes too.
- For TD[®] to calculate Albedo fluxes for planet Earth the Albedo percentage in TD[®] can be used as 33% (0.33) for hot case analysis and 30% (0.3) for cold case analysis.
- Q_{ir} reaching a cube is comprised of the following fluxes:
 1. **Planetary Infrared** – infrared fluxes reflecting off of the planet and reaching the spacecraft.
 2. **Reflected Infrared** – infrared fluxes reflected and emitted off of spacecraft hardware surfaces to the surface in question.
 - TD[®] planet IR is comprised of items 1. and 2. above, the total Q_{ir} received by a cube, which is calculated by Equation (6) above.
 - For TD[®] to calculate Q_{ir} the heat source values normally used for planet Earth are 78 Btu/hr/ft² (246.06 W/m²) for hot case analysis and 75 Btu/hr/ft² (236.6 W/m²) for cold case analysis.

4.0 SPACE ENVIRONMENT SINK TEMPERATURE

As we know for a surface in thermal equilibrium state the radiating energy will be equal to the energy being absorbed by the surface. Hence we can write:

$$Q_{radiated} = Q_{absorbed} \quad (7)$$

$$Q_{radiated} = \sigma \cdot \epsilon_{ir} \cdot (T_{surface}^4 - T_{space}^4)$$

Where

σ (Stefan-Boltzmann constant) = $1.71218 \text{ e-}9 \text{ Btu/hr.ft}^2.\text{R}^4 = 5.67\text{e-}8 \text{ W/m}^2.\text{K}^4$

T_{surface} – cube surface temperature

T_{space} – deep space temperature = $-459.67 \text{ }^\circ\text{F} \approx 0 \text{ }^\circ\text{R}$

$$Q_{\text{radiated}} = \sigma \cdot \epsilon_{\text{ir}} \cdot T_{\text{surface}}^4 \quad (8)$$

Substituting (8) in (7) above

$$\sigma \cdot \epsilon_{\text{ir}} \cdot T_{\text{surface}}^4 = Q_{\text{absorbed}} \quad (9)$$

$$T_{\text{surface}} = (Q_{\text{absorbed}} / \sigma \cdot \epsilon_{\text{ir}})^{1/4} \quad (10)$$

$$Q_{\text{absorbed}} = \alpha_s \cdot Q_{\text{sol}} + \epsilon_{\text{ir}} \cdot Q_{\text{ir}} \quad (5) \text{ above}$$

$$T_{\text{surface}} = ((\alpha_s \cdot Q_{\text{sol}} + \epsilon_{\text{ir}} \cdot Q_{\text{ir}}) / \sigma \cdot \epsilon_{\text{ir}})^{1/4}$$

$$T_{\text{surface}} = \left[\frac{\left(\frac{\alpha_s}{\epsilon_{\text{ir}}} \right) \cdot Q_{\text{sol}} + Q_{\text{ir}}}{\sigma} \right]^{\frac{1}{4}} \quad (11)$$

The Q_{sol} and Q_{ir} in Equation (11) are calculated by HTFLXCAL at a cube location. By using the optical ratio ($\alpha_s / \epsilon_{\text{ir}}$) of an ORU, tool, or spacesuit surface at that location the surface sink temperature can be determined. The cubes inside surfaces are adiabatic hence heat transfer is only via radiant energy

transfer from the cube exterior surfaces due to incident solar flux and incident infrared (IR) flux onto the surfaces. This leads to cube adiabatic surface temperature or sink temperature. Sink temperature is the temperature a surface comes to if only influenced by external radiant heat exchange.

$$T_{\text{sink}} = T_{\text{surface}}$$

Having no capacitance the cube surface temperatures vary with the environment temperatures, there is no delay. This cube average T_{surface} depicts the environment temperatures at cube location, which can be used as T_{sink} for hardware in radiating contact with the environment at that cube location.

5.0 ON-ORBIT SURFACE TEMPERATURE

Because the spacecraft will orbit the Earth and will point generally in various directions, the surfaces of the spacecraft always see different environmental conditions. The maximum and minimum temperatures of a surface in space can be calculated considering various space related factors like direct solar energy, Albedo, Infrared energy from the planet, altitude of the Orbiter, optical properties of the surface, planet radius, etc. There are direct heats input from the sun, from the earth, and from the surrounding components based upon the altitude and beta angles involved. Thermal analysis shown in Wertz and Larson [3] considers the orbital factors to calculate any surface maximum and minimum temperatures in space. The following analysis has been included in here for educational purpose to provide insight into how temperature of a surface that is exposed to space environment is calculated by considering all applicable factors. The analysis results are shown as follows:

$$Q_{\text{sol}} := 1367.23 \frac{\text{W}}{\text{m}^2} \quad \text{Direct solar flux} \qquad Q_{\text{sol}} = 433.41 \frac{\text{BTU}}{\text{ft}^2 \cdot \text{hr}}$$

$$Q_{\text{ir}} := 239.26 \frac{\text{W}}{\text{m}^2} \quad \text{Earth IR flux} \qquad Q_{\text{ir}} = 75.845 \frac{\text{BTU}}{\text{hr} \cdot \text{ft}^2}$$

$$\text{Alb} := 0.3 \quad \text{Albedo, part of solar flux reflected off of planet and diffused to space}$$

$$\sigma_s := 5.67 \cdot 10^{-8} \frac{\text{W}}{\text{m}^2 \cdot \text{K}^4} \quad \text{Stefan-Boltzmann constant}$$

$$\alpha_s := 0.15 \quad \text{Solar absorptivity, 0.15 for radiators, 0.01 for thermal blankets}$$

$$\varepsilon_{\text{ir}} := 0.8 \quad \text{Infrared emissivity, 0.8 for radiators, 0.01 for thermal blankets}$$

$$R_e := 6378 \text{ km} \quad \text{Radius of Earth}$$

$$\text{Alt} := 600 \text{ km} \quad \text{Orbit altitude}$$

$$\rho_e := \frac{R_e}{\text{Alt} + R_e} \quad \text{Angular radius of Earth} \quad (12)$$

$$\rho_e = 0.914$$

$$K_a := 0.664 + 0.521 \rho_e - 0.203 \rho_e^2 \quad (13) \quad \text{A factor which accounts for the reflection of collimated incoming solar energy off a spherical Earth}$$

$$K_a = 0.955$$

$$\text{SIN} := \sin(\rho_e)^2$$

$$\text{SIN} = 0.627$$

Maximum temperature of the surface, with assumed optical properties, exposed to the space environment will be [3]:

$$T_{\text{max_surface}} := \left(\frac{Q_{\text{sol}} \cdot \alpha_s + Q_{\text{ir}} \cdot \varepsilon_{\text{ir}} \cdot \sin(\rho_e)^2 + Q_{\text{sol}} \cdot \text{Alb} \cdot \alpha_s \cdot K_a \cdot \sin(\rho_e)^2}{\sigma_s \cdot \varepsilon_{\text{ir}}} \right)^{\frac{1}{4}} \quad (14)$$

$$T_{\max_{\text{surface}}} = 298.9\text{K} \quad T_{\max_{\text{surface}}} = 538\text{R} \quad T_{\max_{\text{surface}}} = 78.3^{\circ}\text{F}$$

Minimum temperature of the surface, with assumed optical properties, exposed to the space environment will be [3]:

$$T_{\min_{\text{surface}}} := \left(\frac{Q_{\text{ir}} \cdot \epsilon_{\text{ir}} \cdot \sin(\rho_e)^2}{\sigma_s \cdot \epsilon_{\text{ir}}} \right)^{\frac{1}{4}} \quad (15)$$

$$T_{\min_{\text{surface}}} = 226.8\text{K} \quad T_{\min_{\text{surface}}} = 408.2\text{R} \quad T_{\min_{\text{surface}}} = -51.4^{\circ}\text{F}$$

6.0 ASSUMPTIONS AND SPECIFICATIONS

1. Flux cubes dimensions are 1x1x1 ft³.
2. Flux cubes are arithmetic nodes, i.e. have zero capacitance.
3. Flux cubes inner surfaces are adiabatic, i.e. inner surfaces are not radiating to each other and cube surfaces are not connected to each other. Inner surfaces are not active.
4. Cube outer surfaces are optically active and have absorptivity (α) and emissivity (ϵ) as one (1.0).
5. Cubes are one foot above the ISS/Orbiter surfaces.
6. ISS/Orbiter model has articulators which are turned active to generate radiation conductors.
7. One orbital cycle is divided into 48 increments (in 0 to 360 revolving angle).
8. ISS/Orbiter altitude is 200 nm, with beta = 0 degree.
9. Attitude is Yaw (Z axis), Pitch (Y axis), Roll (X axis) = -15, 0, -15, with Z-Nadir (facing Earth).

10. The constants used to generate Q_{sol} and Q_{ir} at selected cube locations are as follows:

- a) Solar Constant = 444.0 Btu/hr.ft² (1400.64 W/m²)
- b) Albedo = 0.3
- c) Earth IR = 77 Btu/hr.ft² (242.9 W/m²)

11. The ISS geometric and SINDA model used in this study are as follows:

- 1) ULF6_LTA_v1_draft2.dwg geometric model
- 2) ULF6_vr6r1_EOL_v1_draft1.rco optical properties
- 3) ULF6_v6r1_v1_draft1.sin SINDA model
- 4) ULF6_Global_User_v1.inc User data
- 5) ULF6_Global_User_v1_draft1.inc User data

12. Cube are named such that cubes submodels appear at the beginning of the 'Submodel Node Tree' in TD[®], so that solar flux arrays in 'Heatrates.hra' file appear starting from array number 2. Array 1 is Time Array.

13. In **NodeDescription.txt** file (**Appendix F**) cube description should be in the same order as submodels appearing in 'Submodel Node Tree' in TD[®].

7.0 METHODOLOGY

A Thermal Desktop (TD[®]) ISS/Orbiter model with all modules mentioned below in 'BUILD' command was used in cube flux generation studies. Small 1 cubic ft cubes were at 11 different locations. The modules included in TD[®] 'Build' command are as follows (will be according to the model being used):

BUILD ISS

A, ORBVES, DETCBM, DETPOR

A, SARLCK, SCETAA, SCETAB, SCOF, SCUPOL

A, SDC1, SDC2, SELC1, SELC2, SESP1, SESP2, SESP3

A, SFGB, SFGBWR, SOYUZ1, SOYUZ2, SPROG, SPROG2

A, SJEM, SJEMEL, SJEMP1, SKUANT, SLAB, SMBS, S50MT

A, SNODE1, SNODE2, SNODE3, SP1, SP3, SP4

A, SP5SPC, SP6STW, SPDM, SPMA1, SPMA2, SPMA3, SS0

A, SS1, SS3, SS4, SS5SPC, SS6, SSM, SZ1, orb160

C *, COA1 (USING SUBMODEL MAIN FOR HEAT FLUX ARRAYS)

*, SPACE, COA0,MAIN

*, cube24, cube26,cube41,cube43,cube44,cube45,cube46

*, cube47,cube63,cube86,cube152

All trackers in ISS model were activated. For cube flux generation program development following cubes were added to the ISS/Orbiter model:

1 = Group 152 - Shuttle Nose, Backside

2 = Group 24 - Lab, Port, Aft

3 = Group 26 - Lab, Stbd, Fwd

4 = Group 41 - FGB, Port

5 = Group 43 - SM, Stbd

6 = Group 44 - SM, Zenith

7 = Group 45 - SM, Port

8 = Group 46 - SM, Nadir

9 = Group 47 - Progress, Aft

10 = Group 63 - S0, Fwd, Port, Zenith

11 = Group 86 - S1, Fwd, Port, Zenith

Cube submodels should appear at the beginning of the 'Submodel Node Tree', so that solar flux arrays in TD[®] generated 'HEATRATES.hra' file (see section 7.1) appear starting from array number 2. Array 1 is Time Array. Node description can be up to 50 characters, starting from word 'Group'.

In case the cube numbers are in consecutive order as 1 to onward then one should make sure cube submodels appear in consecutive order in 'Submodel Node Tree' in Thermal Desktop[®] as Cube01,

Cube02, Cube10, Cube11, Cube20, Cube21 Cube99 so on so forth. If there are more than 100 cubes then three digits should be used to number those as Cube001, Cube002 etc. The intent is that cube models appear in ascending order in 'Submodel Node Tree'.

Each cube has six sides with each side has an area of $1 \times 1 \text{ ft}^2$, and cube sides are not connected to each other. The cube surfaces are adiabatic on inside with outer surfaces optically active and connected with ISS/Orbiter only thru radiation conductors. The cubes inner surfaces are optically inactive, i.e. are not radiating to each other. The cubes are placed 1 foot above the ISS/Orbiter surfaces. See Figure 3 for ISS/Orbiter model and cubes placements.

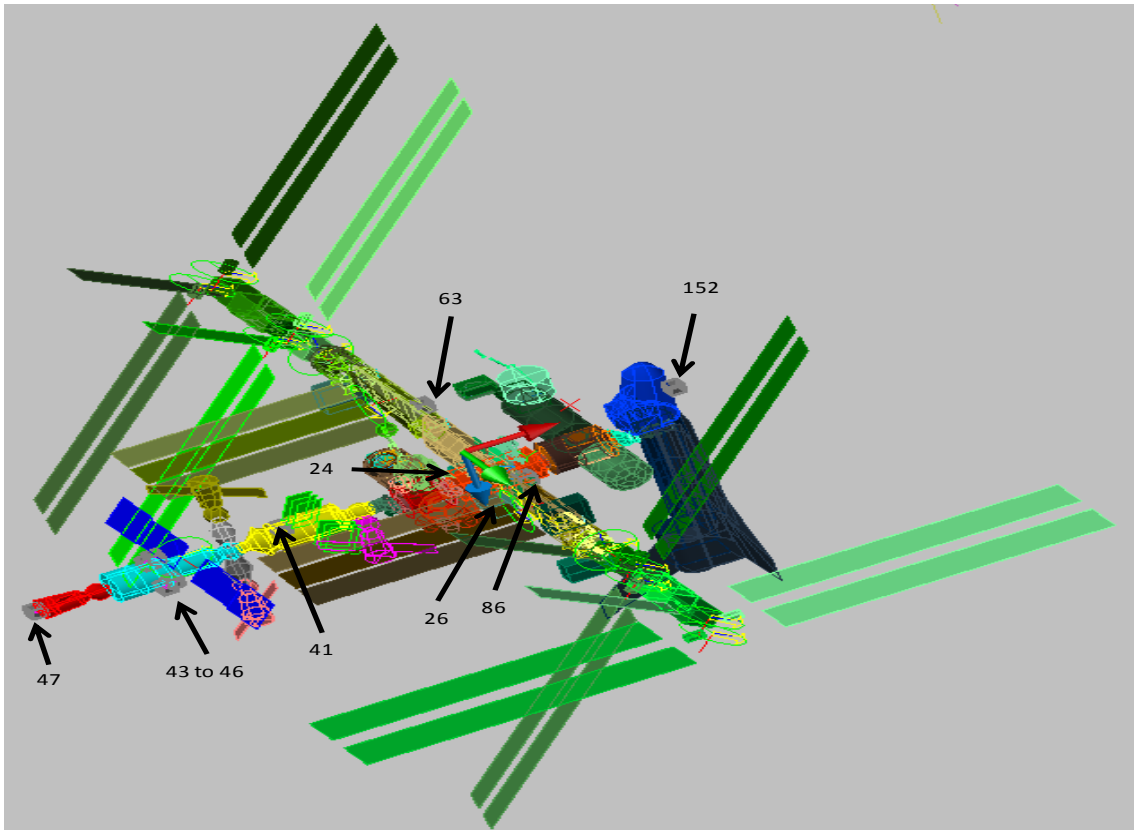

Figure 3. ISS/Orbiter model with cubes.

An orbit was created for the analysis as follows:

Basic orbit: beta = 0 degrees

 Altitude = 200 nm

 Orientation = Z-Nadir, i.e. Z-axis is facing the planet center

 Yaw (z-axis), Pitch (y-axis), Roll (x-axis) = -15, 0, -15 degrees

Increments (equal) in one orbit = hrPos = 48

Planet = Earth

Calculated orbital period = hrPeriod = 1.53258 hours

The solar constants considered are as follows:

Solar flux constant = 444 Btu/hr/ft² = 1400.64 W/m²

Albedo constant = 0.3

Planet IR constant = 77 Btu/hr/ft² = 242.9 W/m²

The ISS and Shuttle are shown in Earth orbit in Figure 4 below:

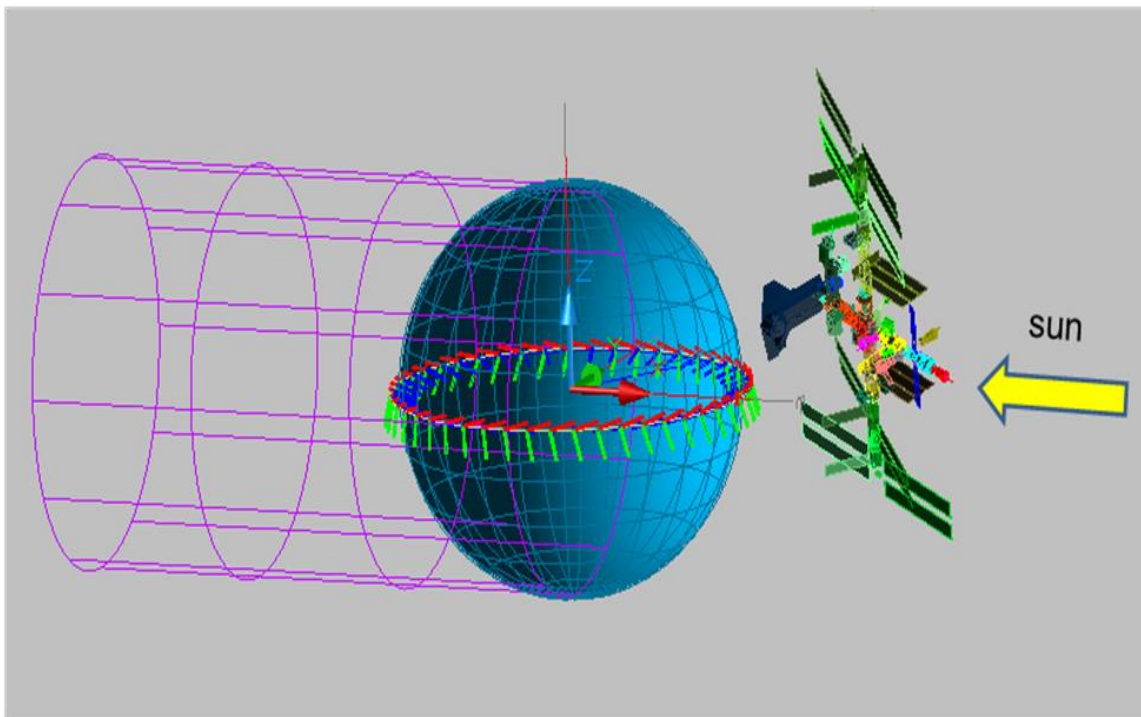

Figure 4. ISS/Shuttle in Earth orbit.

Two cases were set in TD[®] Case Set Manager:

7.1 Thermal Desktop® Case Set 0

The tabs in Case Set 0 were set as follows:

1. Radiation Tasks:

i) Articulating Radks, all trackers active

ii) Heating rates: Control:Heating Rate Sources = Solar, Planetshine, Albedo

Heatrate Output: Output Filename: HEATRATES.hr

Output Submodel: MAIN

S/F Starting Array ID: 1

Output Format: DAIIMC/D11MDA

Calls Determined By Code

Combine SAP arrays into a single array

Output as fluxes

Sources: Solar, Albedo

2. S/F Output: Output Increment: hrPeriod/hrPos

3. SINDA: Control: Global: ABSZRO = -459.6 F, SIGMA = 1.71218e-009 Btu/hr/ft²/R⁴

Thermal: Output = hrPeriod/hrPos

Register: INT:NUSER3 = 3

INT:NUSER4 = 4

INT:NCUBES = 11

hrPeriod = 1.53258 (moved from GLOBAL Symbols to Register Variables)

Operations: see **Appendix A**

Thermal Inputs: Submodel 'MAIN' in 'ARRAY' and 'OUTPUT' Fields:

Array Field:

4001 = SPACE,300

Output Field: see **Appendix B**

Thermal Inputs: Define Submodel 'DUMMY'

7.2 Thermal Desktop® CASE Set 1

The tabs in Case Set 1 were set as follows:

SINDA: Control: Additional User Input:

UID = ENG

DTIMEI = 0.

DTIMEH = (MAIN.A(1+MAIN.NA(1)) - MAIN.A(1+1))/(MAIN.NA(1)-1)

TIMEND = MAIN.A(1+MAIN.NA(1)) - MAIN.A(1+1) \$Change to Max EVA Time

OUTPUT = TIMEND/(MAIN.NA(1)-1)

Registers: see 'HEADER REGISTER DATA, GLOBAL' in **Appendix I**

Registers can be Included as 'Registers.txt' file instead of adding one by one in Global S/F Inputs: REGISTER option in 'SINDA' tab.

Operations: see 'OPERATIONS DATA' in **Appendix I**

Thermal Inputs: Defined Submodel 'Dummy', that has 'ARRAY' field as follows:

Array Field: see **Appendix C**

Thermal Inputs: Define Submodel 'MAIN' with 'Node', 'Conductor', 'CARRAY' fields as follow:

Node: C HEADER NODE DATA, MAIN (Dummy Nodes)

10, 70., 1.0

20, 70., 2.0

Conductor: C HEADER CONDUCTOR DATA, MAIN

C (Dummy Conductor)

10, 10, 20, 1.5

CARRAY Field: see **Appendix F**

8.0 RUNNING THE MODELS

The models were run for Earth and Mars to show the performances and comparison of results. The model can be applied for orbiting spacecraft as well as traveling spacecraft as far as applicable solar, Albedo, and Planet IR are used. The method applied in here is for spacecraft orbiting the planet Earth and Mars.

8.1 ISS/Shuttle Environment Generation for Earth

The analysis can be performed by following two different methods:

Method 1) Run Case Set 0 first and then run SINDA routine outside of TD®:

- a) Case Set 0: Solar and Albedo fluxes are generated for each cube surface at each increment and stored in file HEATRATES.hra, see **Appendix G**
- b) Case Set 0: Temperature of each cube surface at each increment are calculated and stored in file CUBETEMP.US4, see **Appendix H**
- c) Run SINDA routine 'HTFLXCAL':

'FluxGeneration,DA11MC,UsingIndCubeTemp,CorrCubeNum,InclArrays,Tsink.sin'
independently, see **Appendix I**
- d) SINDA 'HTFLXCAL' routine will use solar fluxes 'HEATRATES.hra' and temperature 'CUBETEMP.US4' of each cube surface to calculate IR fluxes for each cube surface and average those to provide Solar and IR fluxes at each cube locations, output sent to 'SOL IR FLUX ARRAYS.US4', see **Appendix J**

- e) SINDA routine 'HTFLXCAL' will calculate Sink Temperatures for materials optical properties provided by 'Optical.txt' file. Sink temperatures output are sent to 'SINK Temperatures.US5', see **Appendix K**

Method 2) Run Case Set 0 and Case Set 1 in single run:

- a) Case Set 0: Solar and Albedo fluxes were generated for each cube surface at each increment and stored in file 'HEATRATES.hra'.
- b) Case Set 0: Temperature of each cube surface at each increment are calculated and stored in file 'CUBETEMP.US4'.
- c) Case Set 1: will use solar fluxes 'HEATRATES.hra' and temperature 'CUBETEMP.US4' of each cube surface to calculate IR fluxes for each cube surface and average those to provide Solar and IR fluxes at each cube locations, output sent to 'SOL IR FLUX ARRAYS.US4'.
- d) Case Set 1: will Calculate Sink Temperatures for materials optical properties provided 'Optical.txt' file. Sink temperatures output are sent to 'SINK Temperatures.US5'.

8.2 ISS/Shuttle Environment Generation for Mars

The model was modified by replacing planet from Earth to Mars. The attitude and beta were kept the same as considered for Earth. The orbit was created for analysis as follows:

Basic orbit: beta = 0 degrees

Altitude = 200 nm

Orientation = Z-Nadir, i.e. Z-axis is facing the planet center

Yaw (z-axis), Pitch (y-axis), Roll (x-axis) = -15, 0, -15 degrees

Increments (equal) in one orbit = hrPos = 48

Planet = Mars

Calculated orbital period = hrPeriod = 1.95033 hours

The solar constants were taken at subsolar orbit as follows [4]:

Solar flux constant = $186.7 \text{ Btu/hr/ft}^2 = 588.96 \text{ W/m}^2$ (mean)
Albedo constant = 0.29 (subsolar peak)
Planet IR constant = $123.6 \text{ Btu/hr/ft}^2 = 389.91 \text{ W/m}^2$ (maximum, near subsolar)

The ISS/Orbiter is shown orbiting the Mars as follows:

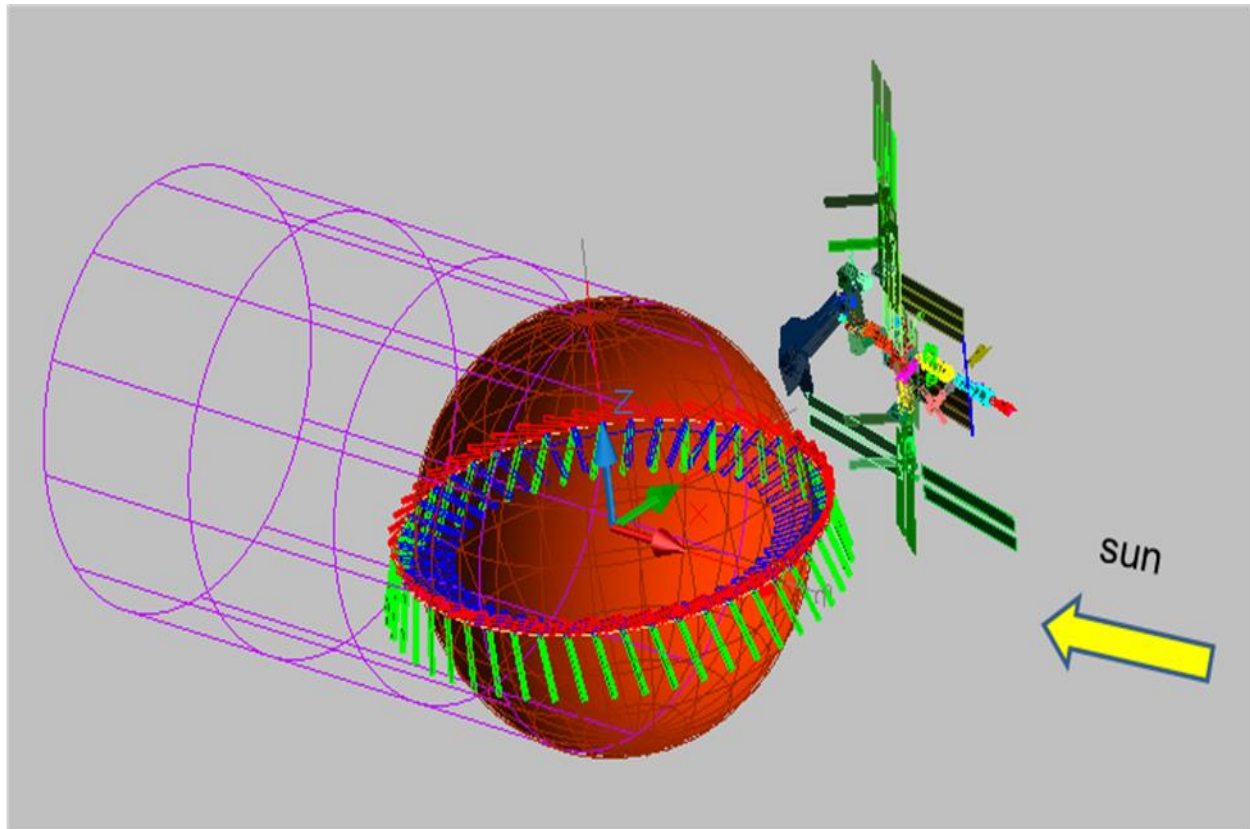

Figure 5. ISS/Shuttle in Mars orbit.

The models were run using method 2, as described in section 8.1 above. The solar and IR fluxes at all cube locations were generated and sent to 'SOL IR FLUX ARRAYS.US4', see **Appendix L**.

The sink temperatures were generated and outputs were sent to 'SINK Temperatures.US5', see **Appendix M**.

The results were compared for ISS/Shuttle environments in Earth and Mars orbits. The sink temperatures for cube locations in Earth and Mars environments are shown in Figure 6 below:

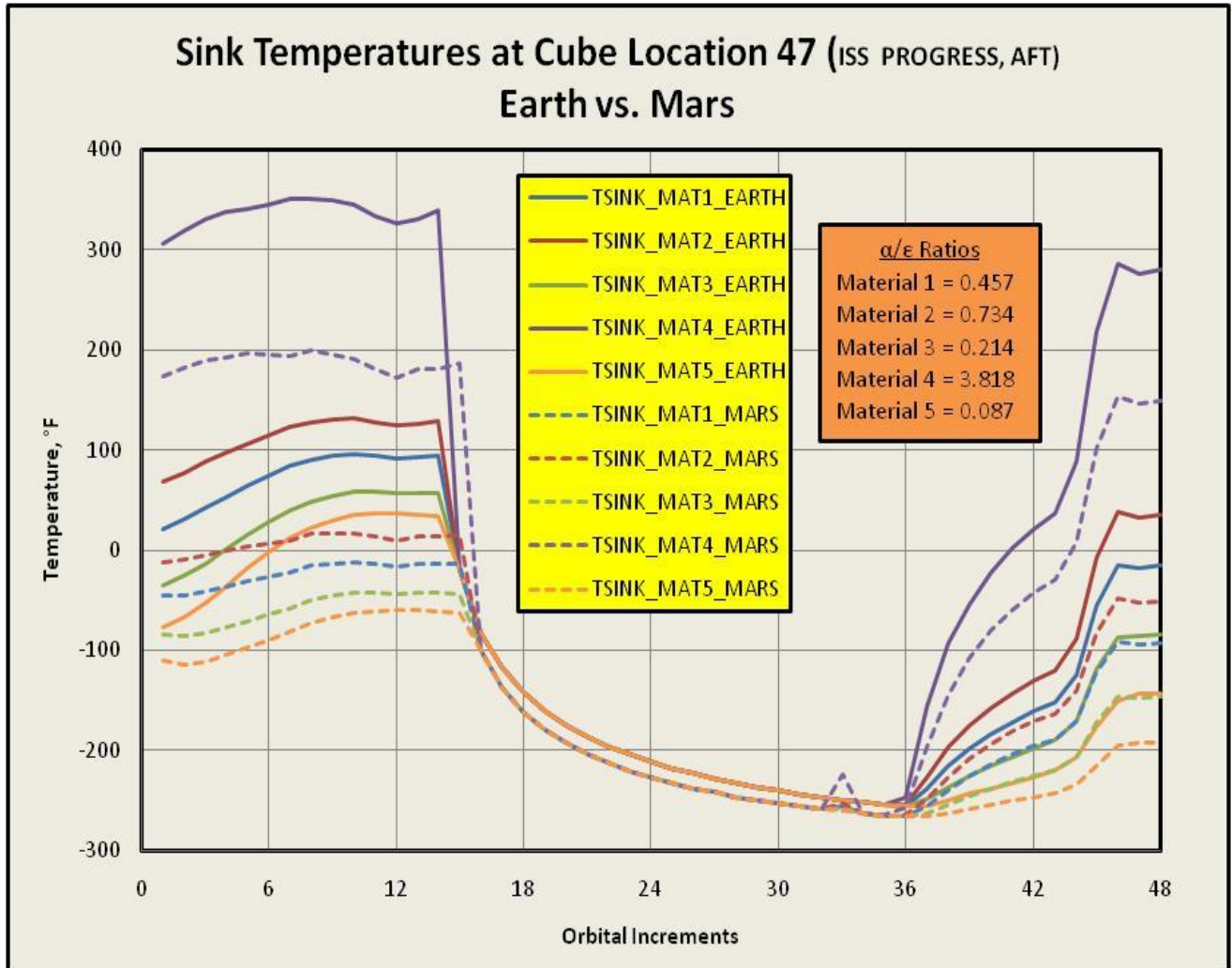

Figure 6. Sink temperature comparison of ISS/Shuttle progress, aft location in Earth vs. Mars orbits.

The sink temperatures at ISS Progress, Aft location are 100 to 150 °F cooler in Mars orbit as compared to Earth Orbit. At no solar condition the sink temperatures are about 20 °F cooler in Mars orbit as compared to Earth orbit.

8.3 Satellite Environment Generation for Lower Earth and Geosynchronous Orbits

A satellite was developed with 29 cubes all around it and it was set to revolve around Earth in lower earth and geosynchronous orbits.

The cube flux method was applied on a Satellite in geosynchronous orbit (GEO) and Lower Earth Orbit (LEO). The Satellite was placed in GEO and LEO with certain beta angle and attitude and analyzed. The solar panels were articulating one towards sun and one towards earth while Satellite orbiting the Earth.

The orbit data are shown below:

Table 1. LEO and GEO Input Data

| Orbit → | LEO | GEO |
|--------------------------------------|----------|----------|
| Altitude (nm) | 200 | 19364.5 |
| Orbital Period (hours) (hrPeriod) | 1.5326 | 24 |
| Pointing | +Z Nadir | +Z Nadir |
| Increments in an Orbit (hrPos) | 48 | 48 |
| Beta (degrees) | 45 | 45 |
| Altitude (YPR) | 90,0,0 | 90,0,0 |
| Solar Flux (Btu/hr/ft ²) | 429.2 | 429.2 |
| Earth IR (Btu/hr/ft ²) | 70.22 | 70.22 |
| Albedo | 0.35 | 0.35 |

The Satellite with cubes is shown in GEO as follows:

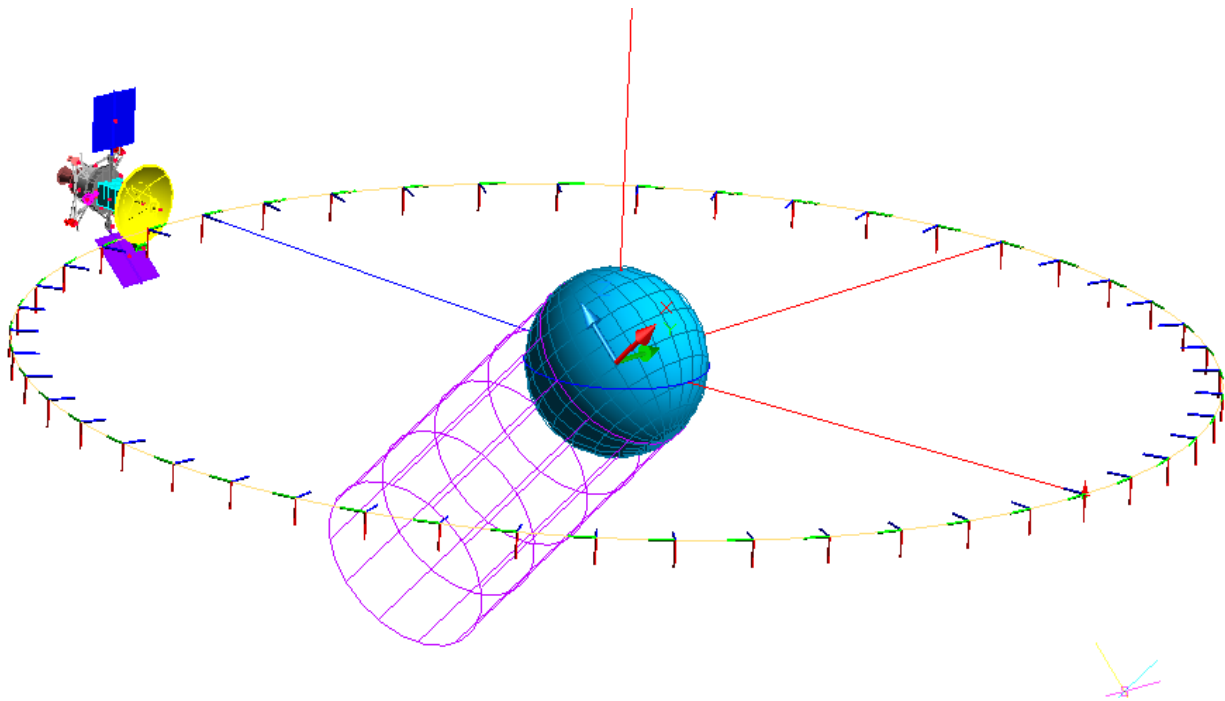

Figure 7. Satellite with flux cubes in GEO.

The resulting Satellite temperature contours after one hour in GEO are as follows:

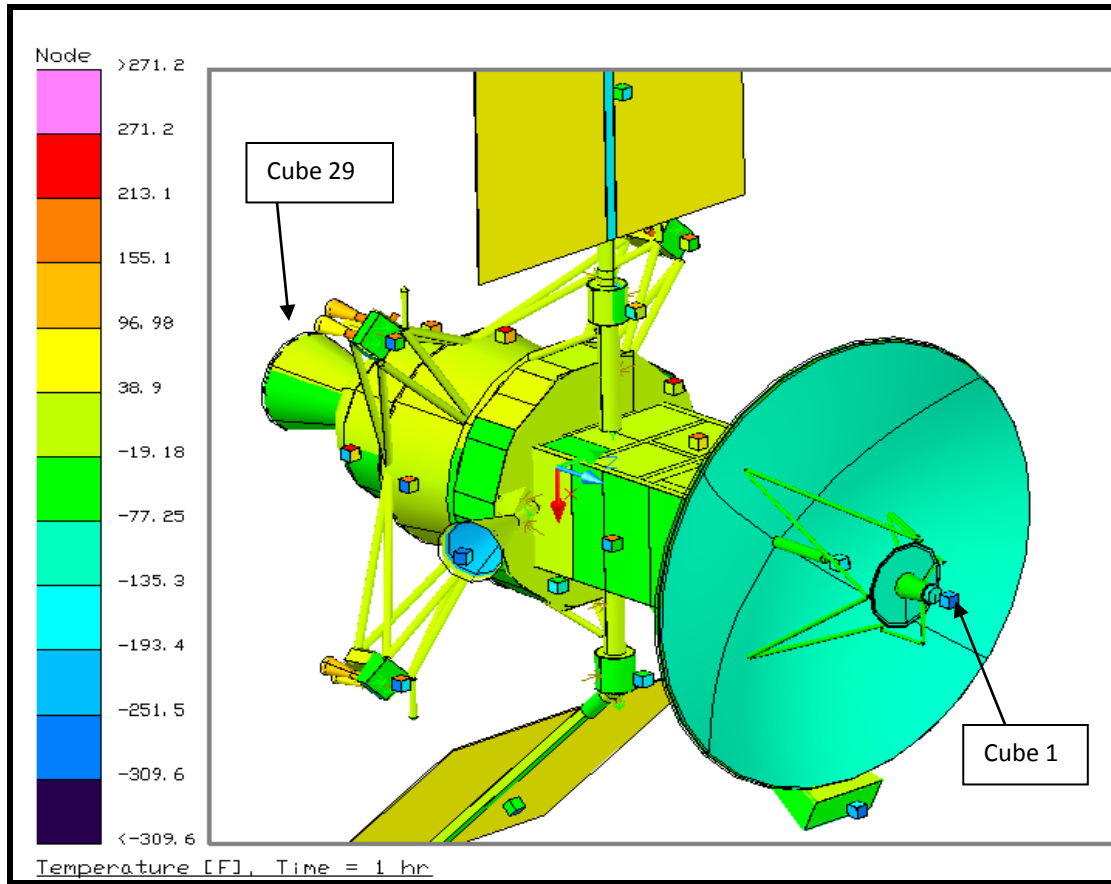

Figure 8. Satellite thermal contours in geosynchronous orbit.

Sink temperatures for several materials were calculated. The GEO and LEO sink temperatures comparison for two (2) cube locations for one material is shown as follows:

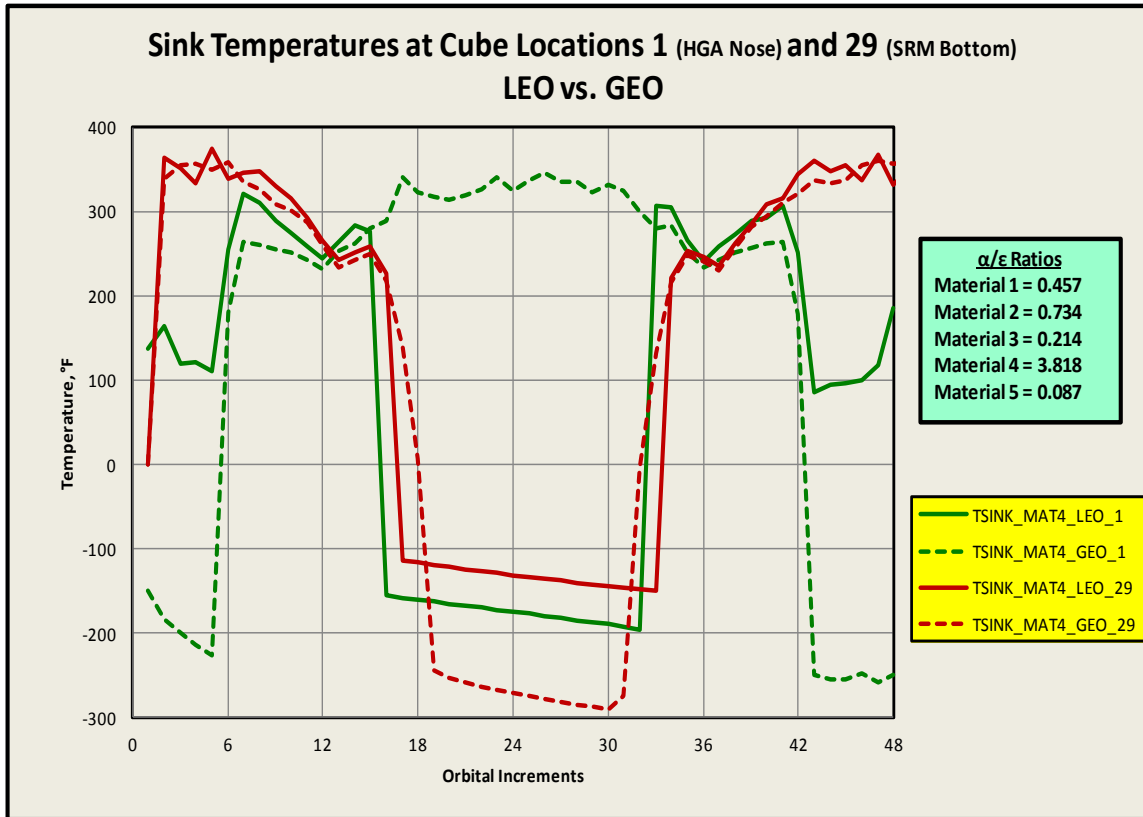

Figure 9. LEO and GEO sink temperatures comparison.

Cube 1 does not get under Earth shade in GEO but it does get under Earth shade in LEO that is why it has lower temperature in LEO while in GEO cube 1 receives full solar flux. Cube 1 has lower temperature in GEO when the Satellite bottom (cube 29) is facing the Sun.

9.0 CONCLUSIONS

1. The procedure can be applied to any planet to generate environments around the satellite.
2. To determine environments around a satellite its thermal model with cubes at critical locations will be required to determine solar and IR fluxes and sink temperatures at those locations.
3. A database of cube fluxes at required attitudes and betas can be developed for an orbiting satellite.
4. Once a fluxes database is generated for a range of orbital beta angle and orbiter attitudes the max and min sink temperatures for six modes, namely instantaneous min, instantaneous max, average min, average max, Dayside average, and Night time average can be determined.

5. The sink temperatures for EVA purposes can be generated or compared using the method outlined in here.
6. Mars environments in dayside were found 100 to 150 °F cooler than Earth orbit, for materials optical properties, orbit definition, and the ISS/Shuttle location selected.
7. Mars environments in nightside, i.e. no direct solar or Albedo fluxes, were found 20 °F cooler than the Earth orbit for materials optical properties, orbit definition, and the ISS/Shuttle location selected.
8. The method can be applied to both orbiting and interplanetary traveling spacecraft as far as admissible travel path is defined. The interplanetary path would calculate applied Solar, Albedo and Planets IR the spacecraft is subjected to when traveling from one planet to another. Some modifications in TD[®] Case Set 0 will be needed for TIMEND and Output Increment.
9. For interplanetary analysis, the best option would probably be a combination of the following:
 - i. Define the planet 1 regular orbit
 - ii. Define a vector list from the regular orbit to a point where Planet 1 has negligible effect on the spacecraft
 - iii. Define the elliptical heliocentric transfer orbit
 - iv. Define a vector list from the point where Planet 2 has negligible effect on the spacecraft to the Planet 2 orbit
 - v. Define the planet 2 regular orbit
10. A good practice would be to create an sphere and use it with a vector list to determine how close the spacecraft must be to the planet to receive a significant amount of energy from the planet. If the spacecraft can receive significant energy at a large distance, it may make sense to solve using the vector lists and heliocentric orbits at the same time. The heliocentric orbit has the correct solar flux (it treats the Sun as a finite black body). When solving two orbits simultaneously, the common sources from one of the orbits should be excluded. In the case of a planetary and heliocentric orbit, the solar calculation from the planetary orbit should be excluded. One would also need to be mindful of eclipses [5].

CONTACT

Dr. Siraj A. Jalali, Oceaneering Space Systems, (281) 228-5482, sjalali@oceaneering.com

NOMENCLATURE, ACRONYMS, ABBREVIATIONS

| | |
|---------------------------------|------------------------------------------------------------------------------------------------|
| Alb | Albedo |
| Alt | Orbit altitude |
| E_p | Total energy emitted by Sun Photosphere |
| I | energy flux |
| K_a | A factor which accounts for the reflection of collimated incoming energy off a spherical Earth |
| PA | Sun's Photosphere surface area |
| Q_{absorbed} | Total heat absorbed by a surface |
| Q_{ir} | Earth infrared flux |
| Q_{radiated} | Total heat radiated by a surface |
| Q_{sol} | Earth solar flux |
| R_e, r_e | Radius of Earth |
| r_p | Photosphere radius |
| T_{sink} | Environment sink temperature |
| T_{surface} | Surface temperature |
| $\alpha_{\text{sol}}, \alpha_s$ | Solar absorptivity of the material for which sink temperature is required |
| ϵ_{ir} | Infrared emissivity of the material for which sink temperature is required |
| σ | Stefan-Boltzmann Constant |
| ρ_e | Angular radius of Earth |

REFERENCES

1. Janet L. Barth, "Space and Atmospheric Environments: from Low Earth Orbits to Deep Space", NASA/Goddard Space Flight Center.
2. Earth's Energy Budget, <http://okfirst.mesonet.org/train/meteorology/EnergyBudget2.html>, Oklahoma Climatological Survey.
3. Wiley J. Larson and James R. Wertz (Editors), Space Mission Analysis and Design, Space Technology Series, Microcosm, Inc. and Kluwer Academic Publishers, 2nd Edition, 1992.
4. David G. Gilmore (Editor), Spacecraft Thermal Control Handbook, volume 1, The Aerospace Corporation, 2nd Edition, 2002.
5. Thermal Desktop, Cullimore and Ring Technologies, Version 5.3, January 2010.
6. R. D. Horton, "ISS Assembly Complete Station Based EVA Thermal Radiation Environments: DAC #5", Lockheed Martin Engineering & Science Services, June 30, 1997.

Appendix A
Case Set 0 – SINDA - Operations

C Operations Block Starts -----

CALL USRFIL(NUSER3,'CUBEAVTEMP.US3','UNKNOWN')

CALL USRFIL(NUSER4,'CUBETEMP.US4','UNKNOWN')

BUILD ISS

A, ORBVES

A, DETCBM, DETPOR

A, SARLCK, SCETAA, SCETAB, SCOF, SCUPOL

A, SDC1, SDC2, SELC1, SELC2, SESP1, SESP2, SESP3

A, SFGB, SFGBWR, SOYUZ1, SOYUZ2, SPROG, SPROG2

A, SJEM, SJEMEL, SJEMP1, SKUANT, SLAB, SMBS, S50MT

A, SNODE1, SNODE2, SNODE3, SP1, SP3, SP4

A, SP5SPC, SP6STW, SPDM, SPMA1, SPMA2, SPMA3, SS0

A, SS1, SS3, SS4, SS5SPC, SS6, SSM, SZ1

*, COA0

C *, COA1 (USING SUBMODEL MAIN FOR HEAT FLUX ARRAYS)

*, SPACE,orb160,MAIN

*, cube24, cube26,cube41,cube43,cube44,cube45,cube46

*, cube47,cube63,cube86,cube152

M DO 200 I = 1,300

MAIN.NA(4001 + I) = I

F 200 CONTINUE

TIMEO = 0.

TIMEND = hrPeriod*1.0

CALL FWDBCK

C Operation Block Ends -----

Appendix B

Case Set 0 – SINDA – Thermal Inputs – submodel Main – OUTPUT field

**C -- CUBE TEMPERATURES ARE WRITTEN IN THE SAME ORDER AS CUBES SUBMODEL NAMES
C -- APPEAR IN SUBMODEL NODE TREE**

```
WRITE(NUSER4,1004)
TIMEN,NA(4001+152),CUBE152.T1,CUBE152.T2,CUBE152.T3,CUBE152.T4,CUBE152.T5,CUBE152.T6
+ ,TIMEN,NA(4001+24),CUBE24.T1,CUBE24.T2,CUBE24.T3,CUBE24.T4,CUBE24.T5,CUBE24.T6
+ ,TIMEN,NA(4001+26),CUBE26.T1,CUBE26.T2,CUBE26.T3,CUBE26.T4,CUBE26.T5,CUBE26.T6
+ ,TIMEN,NA(4001+41),CUBE41.T1,CUBE41.T2,CUBE41.T3,CUBE41.T4,CUBE41.T5,CUBE41.T6
+ ,TIMEN,NA(4001+43),CUBE43.T1,CUBE43.T2,CUBE43.T3,CUBE43.T4,CUBE43.T5,CUBE43.T6
+ ,TIMEN,NA(4001+44),CUBE44.T1,CUBE44.T2,CUBE44.T3,CUBE44.T4,CUBE44.T5,CUBE44.T6
+ ,TIMEN,NA(4001+45),CUBE45.T1,CUBE45.T2,CUBE45.T3,CUBE45.T4,CUBE45.T5,CUBE45.T6
+ ,TIMEN,NA(4001+46),CUBE46.T1,CUBE46.T2,CUBE46.T3,CUBE46.T4,CUBE46.T5,CUBE46.T6
+ ,TIMEN,NA(4001+47),CUBE47.T1,CUBE47.T2,CUBE47.T3,CUBE47.T4,CUBE47.T5,CUBE47.T6
+ ,TIMEN,NA(4001+63),CUBE63.T1,CUBE63.T2,CUBE63.T3,CUBE63.T4,CUBE63.T5,CUBE63.T6
+ ,TIMEN,NA(4001+86),CUBE86.T1,CUBE86.T2,CUBE86.T3,CUBE86.T4,CUBE86.T5,CUBE86.T6
```

```
F1004 FORMAT(1(F12.3,',',I5,6(',',F12.5)))
```

Appendix C
Case Set 1 – SINDA – Thermal Inputs – Submodel Dummy

C ----- ARRAY field starts -----

C HEADER ARRAY DATA, DUMMY

C 'HEADER ARRAY DATA, MAIN' WILL BE IN THE FILE BEING INCLUDED BELOW, SO 'HEADER ARRAY DATA, DUMMY' COMMENTED OUT IN HERE.

C Q_{solar} and Q_{albedo} combined fluxes for the model

INCLUDE D: \Cube Flux\Cube Flux Generation\ISS\HEATRATES.hra

9999 = SPACE, 100 \$ 100 TIME STEPS IN A CYCLE

7000 = SPACE, 2000 \$ 100 TIME STEPS IN A CYCLE X 20 MATERIALS

INCLUDE D: \Cube Flux\Cube Flux Generation\ISS\ISS FLUXGEN\ArraySpace.txt

5001 =

INCLUDE D: \Cube Flux\Cube Flux Generation\ISS\CUBETEMP.US4

6000 =

INCLUDE D: \Cube Flux\Cube Flux Generation\ISS\ISS FLUXGEN\Opticals.txt

C ----- ARRAY field ends -----

See **Appendix D** for ArraySpace.txt, solar flux and IR flux arrays space allocation for 100 time steps. Number of array are same as number of cube locations.

See **Appendix E** for Opticals.txt, material optical properties for sink temperature calculation, and other required inputs.

Appendix D
ArraySpace.txt file

2001 = SPACE, 100
2002 = SPACE, 100
2003 = SPACE, 100
2004 = SPACE, 100
2005 = SPACE, 100
2006 = SPACE, 100
2007 = SPACE, 100
2008 = SPACE, 100
2009 = SPACE, 100
2010 = SPACE, 100
2011 = SPACE, 100

c

3001 = SPACE, 100
3002 = SPACE, 100
3003 = SPACE, 100
3004 = SPACE, 100
3005 = SPACE, 100
3006 = SPACE, 100
3007 = SPACE, 100
3008 = SPACE, 100
3009 = SPACE, 100
3010 = SPACE, 100
3011 = SPACE, 100

Appendix E
Opticals.txt file

5.,11.0,16.9 \$ Number of materials, number of cubes, EVA Start Time
1.,0.38,0.83 \$ AL clear anodized (BOL) absorptivity, emissivity
2.,0.58,0.79 \$ AL clear anodized (EOL) absorptivity, emissivity
3.,0.18,0.84 \$ EMU ORTHO FABRIC absorptivity, emissivity
4.,0.42,0.11 \$ STAINLESS STEEL (BARE) absorptivity, emissivity
5.,0.07,0.80 \$ SILVERIZED TEFLON absorptivity, emissivity

Appendix F

Case Set 1 – SINDA – Thermal Inputs – submodel Main – CARRAY, NodeDescription.txt

C HEADER CARRAY DATA, MAIN

INCLUDE D:\Cube Flux \Cube Flux Generation\ISS\ISS FLUXGEN\NodeDescription.txt

NodeDescription.txt file: Should be in the same order as submodels appear in 'Submodel Node Tree'.

- 1 = Group 152 - Shuttle Nose, Backside
- 2 = Group 24 - Lab, Port, Aft
- 3 = Group 26 - Lab, Stbd, Fwd
- 4 = Group 41 - FGB, Port
- 5 = Group 43 - SM, Stbd
- 6 = Group 44 - SM, Zenith
- 7 = Group 45 - SM, Port
- 8 = Group 46 - SM, Nadir
- 9 = Group 47 - Progress, Aft
- 10 = Group 63 - S0, Fwd, Port, Zenith
- 11 = Group 86 - S1, Fwd, Port, Zenith

Appendix G

HEATRATES.hra File (Extract)

Solar and Albedo Fluxes for Cube Surfaces, TD[®] Output: Heatrates.hra (Extract)

HEADER ARRAY DATA, MAIN

C SINDA/FLUINT data created with Thermal Desktop 5.3 Patch 5a

C

C Generated on Fri May 06 16:40:37 2011

C Generated from database BASE-Earth_beta0_YPR-15_0-15-ULF6_v6r1_EOL_v1_draft1.rch

C solar 444 BTU/hr/ft^2

C albedo 0.3

C Time Array

1= 0.0,3.192861e-002,6.385750e-002,9.578611e-002
1.277150e-001,1.596436e-001,1.915725e-001,2.235011e-001
2.554297e-001,2.873583e-001,3.192861e-001,3.512167e-001
3.831444e-001,4.150722e-001,4.470028e-001,4.789306e-001
5.108583e-001,5.427889e-001,5.747167e-001,6.066472e-001
6.385750e-001,6.705028e-001,7.024333e-001,7.343611e-001
7.662889e-001,7.982195e-001,8.301472e-001,8.620750e-001
8.940055e-001,9.259334e-001,9.578611e-001,9.897917e-001
1.021719e+000,1.053647e+000,1.085578e+000,1.117506e+000
1.149433e+000,1.181364e+000,1.213292e+000,1.245219e+000
1.277150e+000,1.309078e+000,1.341006e+000,1.372936e+000
1.404864e+000,1.436792e+000,1.468722e+000,1.500650e+000
1.532578e+000

C solar albedo arrays for node CUBE152.1

2= 4.315303e+002,1.027859e+002,1.201040e-001,3.019695e-002
2.953015e+000,2.171204e+000, 0.0,1.796876e+000
7.046623e-001,8.470676e-001,7.442019e-001,2.859203e-001
8.936454e-003,1.180577e-002, 0.0, 0.0
0.0, 0.0, 0.0, 0.0
0.0, 0.0, 0.0, 0.0
0.0, 0.0, 0.0, 0.0
0.0, 0.0, 0.0, 0.0
0.0, 0.0, 2.529767e+001,3.444445e+001
3.469708e+001,8.586476e+001,1.239307e+002,1.920550e+002
2.298635e+002,2.729237e+002,3.174184e+002,3.575653e+002
3.917150e+002,4.003851e+002,4.195934e+002,4.286831e+002
4.295495e+002

C solar albedo arrays for node CUBE152.2

3= 1.294517e+002,5.889698e+001,1.735329e+001,1.635620e+001
1.623544e+001,1.342241e+001,1.311985e+001,1.065707e+001
8.012981e+000,7.217085e+000,4.222584e+000,1.561870e+000
2.402064e-002,5.790443e-003,2.262677e+000, 0.0
0.0, 0.0, 0.0, 0.0
0.0, 0.0, 0.0, 0.0
0.0, 0.0, 0.0, 0.0
0.0, 0.0, 0.0, 0.0
0.0, 0.0, 1.158696e+002,1.198972e+002
1.444362e+002,1.473019e+002,1.519179e+002,1.755883e+002
1.915286e+002,1.840873e+002,1.849410e+002,1.868314e+002
1.767685e+002,1.742268e+002,1.651238e+002,1.456259e+002
1.325141e+002

Appendix H
CUBETEMP.US4 File (Extract)
Cube surface temperatures

0.000, 152, 68.00000, 68.00000, 68.00000, 68.00000, 68.00000, 68.00000
0.000, 24, 68.00000, 68.00000, 68.00000, 68.00000, 68.00000, 68.00000
0.000, 26, 68.00000, 68.00000, 68.00000, 68.00000, 68.00000, 68.00000
0.000, 41, 68.00000, 68.00000, 68.00000, 68.00000, 68.00000, 68.00000
0.000, 43, 68.00000, 68.00000, 68.00000, 68.00000, 68.00000, 68.00000
0.000, 44, 68.00000, 68.00000, 68.00000, 68.00000, 68.00000, 68.00000
0.000, 45, 68.00000, 68.00000, 68.00000, 68.00000, 68.00000, 68.00000
0.000, 46, 68.00000, 68.00000, 68.00000, 68.00000, 68.00000, 68.00000
0.000, 47, 68.00000, 68.00000, 68.00000, 68.00000, 68.00000, 68.00000
0.000, 63, 68.00000, 68.00000, 68.00000, 68.00000, 68.00000, 68.00000
0.000, 86, 68.00000, 68.00000, 68.00000, 68.00000, 68.00000, 68.00000
0.032, 152, 75.70926, 7.67398, 35.70163, 10.53522, -63.39496, 40.63260
0.032, 24, 264.20883, 130.21097, 65.22879, 50.59711, 41.25510, 115.52652
0.032, 26, 64.75558, 52.46701, 63.09860, 52.68747, 27.60489, 16.23831
0.032, 41, 260.21506, 115.60562, 55.40866, 13.20367, 15.87564, 90.04276
0.032, 43, 73.97421, 63.80429, 13.49551, 72.85464, 43.52051, 263.25565
0.032, 44, 107.75607, 13.86392, 55.32040, 108.60318, 145.68839, 251.10251
0.032, 45, 70.72647, -13.56442, 12.31885, 103.69864, 54.90829, 255.07419
0.032, 46, -2.23532, 15.33179, 25.02975, -28.52551, 47.27386, 37.81720
0.032, 47, 53.36697, 8.80923, 45.01547, 82.23465, 47.82785, 259.80545
0.032, 63, 249.39566, 124.08157, 146.90573, 64.48996, 22.47412, 161.59494
0.032, 86, 251.58542, 136.28891, 129.62662, 61.97983, -33.19193, 163.00058
0.064, 152, -109.49521, -79.90735, 31.61398, 6.12369, -67.56000, 11.35361

1.533, 152, 261.53757, 90.62167, 44.61526, 12.96808, -61.22812, 62.13492
1.533, 24, 268.01620, 121.32535, 45.06607, 20.99091, 23.68143, 59.70035
1.533, 26, 30.54639, 59.82339, -20.64426, 44.67773, 38.70181, 36.88370
1.533, 41, 256.84299, 51.94305, 53.14273, 8.31635, 4.25687, 25.00723
1.533, 43, 9.93185, 74.92838, 48.97250, 93.84482, 38.82919, 264.59506
1.533, 44, 68.38528, 27.73416, 57.00510, 136.15677, 136.81076, 253.42764
1.533, 45, 3.55331, -12.65869, 40.55615, 116.75735, 56.17490, 254.55478
1.533, 46, -13.98764, 5.79037, 17.41501, -27.49884, 47.21756, 12.92169
1.533, 47, -20.74411, -44.27435, -60.80017, 76.65793, 27.56430, 250.82309
1.533, 63, 249.45761, 166.88333, 157.82718, 68.35709, -10.93375, 151.17880
1.533, 86, 251.88974, 151.13663, 162.17691, 90.74850, -25.25027, 167.91409

Appendix I

DA11MC,UsingIndCubeTemp,CorrCubeNum,InclArrays,Tsink.sin

HTFLXCAL: SINDA Routine to calculate Cube Solar and IR Fluxes and Sink Temperatures

```
CC =====  
CC  
CC PROGRAM: HTFLXCAL: SINDA Routine to calculate Cube Solar and IR Fluxes and Sink Temperatures  
CC  
CC AUTHOR: SIRAJ A. JALALI, Ph.D., P.E.  
CC  
CC DATE: MAY 18, 2011  
CC  
CC OCEANEERING SPACE SYSTEMS  
CC  
CC =====
```

Header OPTIONS DATA
TITLE QSolar and QIR

Output = Flux.out
NODEBUG
MIXARRAY
USER1 = SOL TEMP.US1
USER2 = VARIABLES2.US2

HEADER CONTROL DATA, GLOBAL

UID = ENG
SIGMA = 0.171218E-08
DTIMEI = 0.
DTIMEH = (MAIN.A(1+MAIN.NA(1)) - MAIN.A(1+1))/(MAIN.NA(1)-1)
NLOPT = 1000
NLOOPS = 10000
TIMEND = MAIN.A(1+MAIN.NA(1)) - MAIN.A(1+1) \$INPUT - CHANGE TO MAX EVA TIME
OUTPUT = TIMEND/(MAIN.NA(1)-1)

HEADER NODE DATA, MAIN

10, 70., 1.0
20, 70., 2.0

HEADER CONDUCTOR DATA, MAIN

10, 10, 20, 1.5

HEADER REGISTER DATA, GLOBAL

EVASTART = 0. \$ EVA START TIME, READ FROM OPTICALS.TXT
INT:JJ1 = 0 \$ INDEX FOR SOLAR ARRAY IN HEATRATES.HRA

INT:JJ2 = 0 \$ INDEX FOR SOLAR ARRAY IN HEATRATES.HRA
 INT:JJ3 = 0 \$ INDEX FOR SOLAR ARRAY IN HEATRATES.HRA
 INT:JJ4 = 0 \$ INDEX FOR SOLAR ARRAY IN HEATRATES.HRA
 INT:JJ5 = 0 \$ INDEX FOR SOLAR ARRAY IN HEATRATES.HRA
 INT:JJ6 = 0 \$ INDEX FOR SOLAR ARRAY IN HEATRATES.HRA
 INT:JJ7 = 0 \$ INDEX FOR SOLAR ARRAY IN HEATRATES.HRA
 INT:JJ9999 = 0 \$ ABSOLUTE REFERENCE FOR TIME ARRAY 1
 INT:JJ5001 = 0 \$ ABSOLUTE REFERENCE FOR CUBE SURFACE TEMPERATURES ARRAY
 INT:NUSER3 = 3 \$ USER FILE 3
 INT:NUSER4 = 4 \$ USER FILE 4
 INT:NCUBE = 0 \$ NUMBER OF CUBES, READ FROM OPTICALS.TXT
 INT:NQSOL = 0 \$ SOLAR ARRAYS REFERENCE FROM HEATRATES.HRA
 INT:JQSOL = 0 \$ ABSOLUTE REFERENCE FOR SOLAR ARRAYS
 INT:NQIR = 0 \$ IR ARRAYS REFERENCE
 INT:JQIR = 0 \$ ABSOLUTE REFERENCE FOR IR ARRAYS
 INT:KTCUBE = 0 \$ INDEX FOR READING SOLAR ARRAYS IN HEATRATES.HRA
 INT:LL1 = 0 \$ INDEX FOR CUBE SIDE 1 SOLAR ARRAY IN HEATRATES.HRA
 INT:LL2 = 0 \$ INDEX FOR CUBE SIDE 2 SOLAR ARRAY IN HEATRATES.HRA
 INT:LL3 = 0 \$ INDEX FOR CUBE SIDE 3 SOLAR ARRAY IN HEATRATES.HRA
 INT:LL4 = 0 \$ INDEX FOR CUBE SIDE 4 SOLAR ARRAY IN HEATRATES.HRA
 INT:LL5 = 0 \$ INDEX FOR CUBE SIDE 5 SOLAR ARRAY IN HEATRATES.HRA
 INT:LL6 = 0 \$ INDEX FOR CUBE SIDE 6 SOLAR ARRAY IN HEATRATES.HRA
 INT:NDIFF = 0 \$ INDEX FOR PRINTING TIME ARRAY
 INT:NN2000 = 0 \$ RENAMING SOLAR ARRAYS AS 2000 SERIES
 INT:NN3000 = 0 \$ RENAMING IR ARRAYS AS 3000 SERIES
 INT:NNSOL = 0 \$ ABSOLUTE REFERENCE FOR SOLAR ARRAY
 INT:NNIR = 0 \$ ABSOLUTE REFERENCE FOR IR ARRAY
 INT:NSA = 2 \$ SOLAR ARRAY START NUMBER IN THERMAL DESKTOP OUTPUT FILE
 INT:NSIDES = 6 \$ NUMBER OF CUBE SIDES
 INT:IISUM = 0 \$ SUMMING INDEX
 INT:NCOL = 6 \$ NUMBER OF COLUMNS IN OUTPUT ARRAYS PRINTED
 EVA1 = 0. \$ STORING TIME 1ST OF 6 COLUMNS FOR PRINTING
 EVA2 = 0. \$ STORING TIME 2ND OF 6 COLUMNS FOR PRINTING
 EVA3 = 0. \$ STORING TIME 3RD OF 6 COLUMNS FOR PRINTING
 EVA4 = 0. \$ STORING TIME 4TH OF 6 COLUMNS FOR PRINTING
 EVA5 = 0. \$ STORING TIME 5TH OF 6 COLUMNS FOR PRINTING
 EVA6 = 0. \$ STORING TIME 6TH OF 6 COLUMNS FOR PRINTING
 INT:KTIME = 0 \$ TEMPERATURE READ OUT IN ARRAY CUBETEMP.US4
 INT:KTSUM = 0 \$ INDEX TO READ CUBE TEMPERATURE IN CUBETEMP.US4
 SUMQIR1 = 0. \$ CALCULATING QIR FOR CUBE SIDE 1
 SUMQIR2 = 0. \$ CALCULATING QIR FOR CUBE SIDE 2
 SUMQIR3 = 0. \$ CALCULATING QIR FOR CUBE SIDE 3
 SUMQIR4 = 0. \$ CALCULATING QIR FOR CUBE SIDE 4
 SUMQIR5 = 0. \$ CALCULATING QIR FOR CUBE SIDE 5
 SUMQIR6 = 0. \$ CALCULATING QIR FOR CUBE SIDE 6
 INT:KTJUMP = 0 \$ JUMPING TO NEXT CUBE SOLAR FLUX ARRAY IN HEATRATES.HRA
 INT:KCSUM = 0 \$ INDEX TO NEXT CUBE SOLAR FLUX ARRAY IN HEATRATES.HRA
 INT:NC2000 = 0 \$ SOLAR FLUX ARRAY SERIES FOR PRINTING
 INT:NC3000 = 0 \$ IR FLUX ARRAY SERIES FOR PRINTING
 INT:NNCUBE = 0 \$ INDEX TO JUMP TO STARTING ARRAY OF SOLAR CUBE IN HEATRATES.HRA
 INT:NMAT = 0 \$ NUMBER OF MATERIALS TSINK TO BE CALCULATED, READ FROM ARRAY 6000
 INT:MAT1 = 0 \$ MATERIAL OPTICAL ARRAY INDEX FOR ABSORBTIVITY

```

INT:MAT2 = 0      $ MATERIAL OPTICAL ARRAY INDEX FOR EMISSIVITY
INT:J6000 = 0    $ ABSOLUTE ARRAY FOR OPTICAL PROPERTIES
INT:J7000 = 0    $ ABSOLUTE ARRAY FOR SINK TEMPERATURES
INT:NTEMP = 0    $ TEMPERATURE ARRAY 7000 INDEX
OPRATIO = 0.     $ ABSORBTIVITY / EMISSIVITY RATIO
INT:KMAT = 0     $ SINK TEMP INDEX WITHIN EACH MATERIAL

```

HEADER ARRAY DATA, DUMMY

C 'HEADER ARRAY DATA, MAIN' WILL BE IN THE FILE BEING INCLUDED BELOW, SO COMMENTED OUT IN HERE.
C ALL ARRAYS ARE IN SUBMODEL MAIN.

C Qsolar and Qalbedo combined fluxes for the model
INCLUDE D:\ Cube Flux\Cube Flux Generation\ISS\HEATRATES.hra

```

9999 = SPACE, 100      $ TIME ARRAY FOR 100 INCREMENTS IN A CYCLE

7000 = SPACE, 2000     $ 100 TIME INCREMENTS IN A CYCLE x 20 MATERIALS

```

C ---- ARRAYS 2000 and 3000 SERIES ARE DEFINED FOR SOLAR FLUX and IR FLUX SPACE ALLOCATIONS
INCLUDE D:\ Cube Flux\Cube Flux Generation\ISS\ISS FLUXGEN\ArraySpace.txt

C ---- CUBE SURFACE TEMPERATURES ARE INCLUDED
5001 =
INCLUDE D:\ Cube Flux\Cube Flux Generation\ISS\CUBETEMP.US4

C ---- MATERIAL OPTICAL PROPERTIES AND OTHER VARIABLES ARE READ
6000 =
INCLUDE D:\ Cube Flux\Cube Flux Generation\ISS\ISS FLUXGEN\Opticals.txt

C ---- CARRAY IS INCLUDED FOR CUBE DESCRIPTIONS
HEADER CARRAY DATA, MAIN
INCLUDE D:\ Cube Flux\Cube Flux Generation\ISS\ISS FLUXGEN\NodeDescription.txt

HEADER OPERATION DATA
CALL USRFIL(NUSER3,'SOL IR FLUXES.US3','UNKNOWN')
CALL USRFIL(NUSER4,'SOL IR FLUX ARRAYS.US4', 'UNKNOWN')
CALL USRFIL(NUSER5,'SINK TEMPERATURES.US5', 'UNKNOWN')

BUILD MODEL, MAIN
DEFMOD MAIN

```

CALL ARYTRN('MAIN',9999,JJ9999)
CALL ARYTRN('MAIN',1,JJ1)
CALL ARYTRN('MAIN',5001,JJ5001)
CALL ARYTRN('MAIN',6000,J6000)
C -----READ FROM ARRAY 6000 -----
F   NCUBE = A(J6000+2)
F   EVASTART = A(J6000+3)

```

C-----

```
M      DO 100 KK = 1,NA1
        A(9999 + KK) = A(1 + KK)
F      A(JJ9999 + KK) = A(JJ1 + KK)
F 100  Continue
```

CALL FWDBCK

CALL TPRINT ('ALL')

C----- CALCULATING QSOL AND QIR -----

IISUM = 1

```
M      DO 600 II = NSA, NCUBE*NSIDES-4, NSIDES
```

KTJUMP = KTCUBE*(NSIDES+2)

```
CALL ARYTRN('MAIN',II ,JJ2)
CALL ARYTRN('MAIN',II+1,JJ3)
CALL ARYTRN('MAIN',II+2,JJ4)
CALL ARYTRN('MAIN',II+3,JJ5)
CALL ARYTRN('MAIN',II+4,JJ6)
CALL ARYTRN('MAIN',II+5,JJ7)
```

```
F      NQSOL = 2000 + (II-IISUM)
```

```
F      NQIR = 3000 + (II-IISUM)
```

```
F      IISUM = IISUM + 5
```

CALL ARYTRN('MAIN',NQSOL,JQSOL)

CALL ARYTRN('MAIN',NQIR,JQIR)

```
M      DO 700 JJ = 1 , NA1
```

```
F      A(JQSOL+JJ)=(A(JJ2+JJ)+A(JJ3+JJ)+A(JJ4+JJ)+A(JJ5+JJ)+A(JJ6+JJ)+A(JJ7+JJ))/6.0
```

KTIME = KTJUMP+KTSUM+2

```
F      SUMQIR1 = SIGMA*((A(JJ5001+(KTIME+1))+460.0)**4.0) - A(JJ2+JJ)
```

```
F      SUMQIR2 = SIGMA*((A(JJ5001+(KTIME+2))+460.0)**4.0) - A(JJ3+JJ)
```

```
F      SUMQIR3 = SIGMA*((A(JJ5001+(KTIME+3))+460.0)**4.0) - A(JJ4+JJ)
```

```
F      SUMQIR4 = SIGMA*((A(JJ5001+(KTIME+4))+460.0)**4.0) - A(JJ5+JJ)
```

```
F      SUMQIR5 = SIGMA*((A(JJ5001+(KTIME+5))+460.0)**4.0) - A(JJ6+JJ)
```

```
F      SUMQIR6 = SIGMA*((A(JJ5001+(KTIME+6))+460.0)**4.0) - A(JJ7+JJ)
```

```
F      A(JQIR+JJ) = (SUMQIR1+SUMQIR2+SUMQIR3+SUMQIR4+SUMQIR5+SUMQIR6)/6.0
```

```

        KTSUM = NCUBE*JJ*(NSIDES+2)

F      WRITE(NUSER1,550) NQSOL, JJ, A(JJ2+JJ), A(JJ3+JJ), A(JJ4+JJ), A(JJ5+JJ), A(JJ6+JJ), A(JJ7+JJ)
F      +   , A(JQSOL+JJ), A(JJ5001+(KTIME+1)), A(JJ5001+(KTIME+2)), A(JJ5001+(KTIME+3))
F      +   , A(JJ5001+(KTIME+4)), A(JJ5001+(KTIME+5)), A(JJ5001+(KTIME+6))
F 550  FORMAT(2(I5), 13(F12.5))

F      WRITE(NUSER3,500) JJ, NQSOL, A(JQSOL+JJ), NQIR, A(JQIR+JJ), KTSUM, KTIME
F 500  FORMAT(2X, 'JJ NQSOL QSOL NQIR  QIR KTSUM KTIME  =', I5, 2X, I5, 2X, F12.7,
F      +   I5, 2X, F12.7, 2(2X, I5))

F 700  CONTINUE

        KTCUBE = KTCUBE + 1

        KTSUM = 0

F 600  CONTINUE

C -----PRINING TIME ARRAY -----

        WRITE (NUSER4,880) EVASTART
F 880  FORMAT('EVA START TIME (Hour) = ', F12.5, '/', 'C TIME ARRAY (Hour)', '/', '1000 =')
M      DO 800 LL = 1, NA1-NCOL, NCOL
        LL1 = LL+1
        LL2 = LL+2
        LL3 = LL+3
        LL4 = LL+4
        LL5 = LL+5
        LL6 = LL+6
        NDIFF = NA1 - LL

        EVA1 = A(9999+LL1)+EVASTART
        EVA2 = A(9999+LL2)+EVASTART
        EVA3 = A(9999+LL3)+EVASTART
        EVA4 = A(9999+LL4)+EVASTART
        EVA5 = A(9999+LL5)+EVASTART
        EVA6 = A(9999+LL6)+EVASTART

IF (NDIFF .EQ. 5) THEN
    WRITE (NUSER4,850) EVA1,EVA2,EVA3,EVA4,EVA5

ELSEIF (NDIFF .EQ. 4) THEN
    WRITE (NUSER4,840) EVA1,EVA2,EVA3,EVA4

ELSEIF (NDIFF .EQ. 3) THEN
    WRITE (NUSER4,830) EVA1,EVA2,EVA3

ELSEIF (NDIFF .EQ. 2) THEN

```



```

WRITE (NUSER4,820) EVA1,EVA2

ELSEIF (NDIFF .EQ. 1) THEN
WRITE (NUSER4,810) EVA1

ELSE
WRITE (NUSER4,860) EVA1,EVA2,EVA3,EVA4,EVA5,EVA6

F 860    FORMAT(F12.5,5(',',F12.5))
F 850    FORMAT(F12.5,4(',',F12.5))
F 840    FORMAT(F12.5,3(',',F12.5))
F 830    FORMAT(F12.5,2(',',F12.5))
F 820    FORMAT(F12.5,',',F12.5)
F 810    FORMAT(F12.5)

ENDIF

F 800    CONTINUE
        WRITE(NUSER4,890)
F 890    FORMAT(/)

c ----- Printing Solar Flux Arrays -----
M    DO 1000 MM = 1,NCUBE

        NN2000 = MM+2000
        NN3000 = MM+3000

        NNCUBE = KCSUM + 2
F    NC2000 = 2000+NA(JJ5001+NNCUBE)
F    NC3000 = 3000+NA(JJ5001+NNCUBE)

F    WRITE(NUSER4,980) UCA(MM),NC2000,NA(JJ5001+NNCUBE)

F 980    FORMAT('C',2X,A80/,I5,'=$ INCIDENT SOLAR FLUX (Btu/hr/ft^2) ARRAY - LOCATION -',I5)

        CALL ARYTRN('MAIN',NN2000,NNSOL)

M    DO 900 LL = 1,NA1-NCOL,NCOL
        LL1 = LL+1
        LL2 = LL+2
        LL3 = LL+3
        LL4 = LL+4
        LL5 = LL+5
        LL6 = LL+6
        NDIFF = NA1 - LL

        IF (NDIFF .EQ. 5) THEN
F    WRITE (NUSER4,950) A(NNSOL+LL1),A(NNSOL+LL2),A(NNSOL+LL3),A(NNSOL+LL4),A(NNSOL+LL5)

        ELSEIF (NDIFF .EQ. 4) THEN
F    WRITE (NUSER4,940) A(NNSOL+LL1),A(NNSOL+LL2),A(NNSOL+LL3),A(NNSOL+LL4)

```

```

ELSEIF (NDIFF .EQ. 3) THEN
F      WRITE (NUSER4,930) A(NNSOL+LL1),A(NNSOL+LL2),A(NNSOL+LL3)

ELSEIF (NDIFF .EQ. 2) THEN
F      WRITE (NUSER4,920) A(NNSOL+LL1),A(NNSOL+LL2)

ELSEIF (NDIFF .EQ. 1) THEN
F      WRITE (NUSER4,910) A(NNSOL+LL1)

ELSE
F      WRITE(NUSER4,960) A(NNSOL+LL1), A(NNSOL+LL2), A(NNSOL+LL3), A(NNSOL+LL4), A(NNSOL+LL5)
F +    A(NNSOL+LL6)

F 960    FORMAT(F12.5,5(',',F12.5))
F 950    FORMAT(F12.5,4(',',F12.5))
F 940    FORMAT(F12.5,3(',',F12.5))
F 930    FORMAT(F12.5,2(',',F12.5))
F 920    FORMAT(F12.5,',',F12.5)
F 910    FORMAT(F12.5)

      ENDIF

F 900 CONTINUE

      WRITE(NUSER4,990)
F 990 FORMAT(/)

C----- Printing IR Flux Arrays -----

F      WRITE(NUSER4,1180) UCA(MM),NC3000,NA(JJ5001+NNCUBE)
F1180  FORMAT('C',2X,A80/,I5,'=      $ INCIDENT IR FLUX (Btu/hr/ft^2) ARRAY  - LOCATION ',I5)

      CALL ARYTRN('MAIN',NN3000,NNIR)

M      DO 1100 LL = 1,NA1-NCOL,NCOL
          LL1 = LL+1
          LL2 = LL+2
          LL3 = LL+3
          LL4 = LL+4
          LL5 = LL+5
          LL6 = LL+6
          NDIFF = NA1 - LL

      IF (NDIFF .EQ. 5) THEN
F      WRITE (NUSER4,1150) A(NNIR+LL1),A(NNIR+LL2),A(NNIR+LL3),A(NNIR+LL4),A(NNIR+LL5)

      ELSEIF (NDIFF .EQ. 4) THEN
F      WRITE (NUSER4,1140) A(NNIR+LL1),A(NNIR+LL2),A(NNIR+LL3),A(NNIR+LL4)

      ELSEIF (NDIFF .EQ. 3) THEN
F      WRITE (NUSER4,1130) A(NNIR+LL1),A(NNIR+LL2),A(NNIR+LL3)

```

```

ELSEIF (NDIFF .EQ. 2) THEN
F    WRITE (NUSER4,1120) A(NNIR+LL1),A(NNIR+LL2)

ELSEIF (NDIFF .EQ. 1) THEN
F    WRITE (NUSER4,1110) A(NNIR+LL1)

ELSE
F    WRITE (NUSER4,1160) A(NNIR+LL1),A(NNIR+LL2),A(NNIR+LL3),A(NNIR+LL4),A(NNIR+LL5),A(NNIR+LL6)

F1160    FORMAT(F12.5,5(', ',F12.5))
F1150    FORMAT(F12.5,4(', ',F12.5))
F1140    FORMAT(F12.5,3(', ',F12.5))
F1130    FORMAT(F12.5,2(', ',F12.5))
F1120    FORMAT(F12.5,', ',F12.5)
F1110    FORMAT(F12.5)

ENDIF

F1100    CONTINUE

WRITE(NUSER4,1190)
F1190    FORMAT(/)

KCSUM = KCSUM + 8

F1000    CONTINUE

C ----- Calculating Sink Temperatures -----

CALL ARYTRN('MAIN',6000,J6000)
CALL ARYTRN('MAIN',7000,J7000)

F    NMAT = A(J6000+1)

M    DO 1200 MM = 1,NCUBE

F    WRITE(NUSER5,1220) UCA(MM),NMAT
F1220    FORMAT(2X,/, 'SINK TEMPERATURES FOR: ',A50,/,
F    + 'NUMBER OF MATERIALS = ',I3)

NQSQL = MM+2000
NQIR = MM+3000

CALL ARYTRN('MAIN',NQSQL,JQSQL)
CALL ARYTRN('MAIN',NQIR,JQIR)

M    DO 1300 I2 = 1,NMAT
MAT1 = I2 + 2*(I2+1)
MAT2 = MAT1 + 1
NTEMP = (I2-1)*NA1

```

```

F      OPRATIO = A(J6000+MAT1)/A(J6000+MAT2)

      WRITE(NUSER5,1230) I2,A(6000+MAT1),A(6000+MAT2),OPRATIO
F1230  FORMAT('Material ',I3,', Absorbivity = ',F6.3,', Emissivity = ',F6.3,', Ratio (a/e) = ',F7.4)

M      DO 1400 KKK = 2,NA1

F      KMAT = KKK + NTEMP

F      A(J7000+KMAT) = ((OPRATIO*A(JQSOL+KKK) + A(JQIR+KKK))/SIGMA)**0.25 - 460.0

F1400  CONTINUE

F1300  CONTINUE

C----- Printing Sink Temperatures -----

      WRITE(NUSER5,1510) NMAT
F1510  FORMAT(/,'SINK TEMPERATURES FOR',I3,' MATERIALS',/,
F      + 'TIME = Hour, QSOL AND QIR = Btu/hr/ft^2, TEMP = DegF ',//,6X,
F      + 'TIME    QSOL    QIR  TSINK_MAT1 TSINK_MAT2 TSINK_MAT3 TSINK_MAT4 TSINK_MAT5')

M      DO 1590 KK = 2,NA1

      LL1 = KK+NA1
      LL2 = KK+2*NA1
      LL3 = KK+3*NA1
      LL4 = KK+4*NA1

      IF (NMAT .EQ. 1) THEN
F      WRITE (NUSER5,1515) A(JJ9999+KK)+EVASTART,A(JQSOL+KK),A(JQIR+KK),A(J7000+KK)
F1515  FORMAT(3(2X,F10.5),2X,F8.2)

      ELSEIF (NMAT .EQ. 2) THEN
F      WRITE (NUSER5,1525) A(JJ9999+KK)+EVASTART,A(JQSOL+KK),A(JQIR+KK),A(J7000+KK),A(J7000+LL1)
F1525  FORMAT(3(2X,F10.5),2(2X,F8.2))

      ELSEIF (NMAT .EQ. 3) THEN
F      WRITE (NUSER5,1535) A(JJ9999+KK)+EVASTART,A(JQSOL+KK),A(JQIR+KK),A(J7000+KK),A(J7000+LL1),
F      + A(J7000+LL2)
F1535  FORMAT(3(2X,F10.5),3(2X,F8.2))

      ELSEIF (NMAT .EQ. 4) THEN
F      WRITE (NUSER5,1545) A(JJ9999+KK)+EVASTART,A(JQSOL+KK),A(JQIR+KK),A(J7000+KK),A(J7000+LL1),
F      + A(J7000+LL2),A(J7000+LL3)
F1545  FORMAT(3(2X,F10.5),4(2X,F8.2))

```

```

ELSEIF (NMAT .EQ. 5) THEN
F    WRITE (NUSER5,1555) A(JJ9999+KK)+EVASTART,A(JQSOL+KK),A(JQIR+KK),A(J7000+KK),A(J7000+LL1),
F    + A(J7000+LL2),A(J7000+LL3),A(J7000+LL4)
F1555  FORMAT(3(2X,F10.5),5(2X,F8.2))

      ENDIF

F1590  CONTINUE

F1200  CONTINUE

C ----- Printout just to check individual cube surfaces fluxes and temperatures (IGNORE) -----

HEADER OUTPUT CALLS, MAIN
      WRITE(NUSER2, 300) TIMEN, JQSOL, JQIR
F300   FORMAT('TIME JQSOL NQSOL',F12.7,2(2X,F12.7))

HEADER VARIABLES 0, MAIN

      WRITE(NUSER2, 350) TIMEN,NQSOL,NQIR
F350   FORMAT('TIME NQSOL NQIR',F12.7,2(I10))

HEADER VARIABLES 2, MAIN
      WRITE(NUSER2, 400) TIMEN,KTSUM,KTIME
F400   FORMAT('TIME KTSUM KTIME',F12.7,2(I10))

END OF DATA

```

Appendix J
SOL IR FLUX ARRAYS.US4 File (Extract)

Solar and IR Fluxes at Cube Locations (Earth Orbit)

EVA START TIME (HOUR) = 16.90000

C TIME ARRAY

1000 =

| | | | | | |
|-----------|-----------|-----------|-----------|-----------|----------|
| 16.93193, | 16.96386, | 16.99579, | 17.02771, | 17.05964, | 17.09157 |
| 17.12350, | 17.15543, | 17.18736, | 17.21929, | 17.25122, | 17.28314 |
| 17.31507, | 17.34700, | 17.37893, | 17.41086, | 17.44279, | 17.47472 |
| 17.50665, | 17.53857, | 17.57050, | 17.60243, | 17.63436, | 17.66629 |
| 17.69822, | 17.73015, | 17.76208, | 17.79400, | 17.82593, | 17.85786 |
| 17.88979, | 17.92172, | 17.95365, | 17.98558, | 18.01751, | 18.04943 |
| 18.08136, | 18.11329, | 18.14522, | 18.17715, | 18.20908, | 18.24100 |
| 18.27294, | 18.30486, | 18.33679, | 18.36872, | 18.40065, | 18.43258 |

C GROUP 152 - SHUTTLE NOSE, BACKSIDE

2152= \$ INCIDENT SOLAR FLUX ARRAY - LOCATION - 152

| | | | | | |
|------------|------------|------------|------------|------------|-----------|
| 58.84053, | 33.03804, | 31.10059, | 28.39160, | 24.62483, | 21.15456 |
| 18.12162, | 14.53844, | 10.91728, | 7.60940, | 3.29098, | 0.59027 |
| 0.02211, | 0.38010, | 0.00000, | 0.00000, | 0.00000, | 0.00000 |
| 0.00000, | 0.00000, | 0.00000, | 0.00000, | 0.00000, | 0.00000 |
| 0.00000, | 0.00000, | 0.00000, | 0.00000, | 0.00000, | 0.00000 |
| 0.00000, | 0.00000, | 0.00000, | 128.79700, | 123.24378, | 124.33167 |
| 132.76498, | 143.50902, | 150.62096, | 161.36725, | 167.76506, | 167.22888 |
| 166.86443, | 167.75914, | 150.30550, | 144.65431, | 128.21388, | 126.04385 |

C GROUP 152 - SHUTTLE NOSE, BACKSIDE

3152= \$ INCIDENT IR FLUX ARRAY - LOCATION - 152

| | | | | | |
|-----------|-----------|-----------|-----------|-----------|----------|
| 34.51741, | 28.21892, | 23.47870, | 20.87336, | 17.97002, | 16.57041 |
| 14.94577, | 13.77933, | 12.87545, | 12.08064, | 10.75601, | 9.91682 |
| 9.39068, | 8.05332, | 6.62710, | 5.44979, | 4.85847, | 4.98695 |
| 4.03009, | 3.72052, | 3.45872, | 3.47024, | 4.63325, | 2.90809 |
| 2.88645, | 2.45449, | 2.43088, | 2.28691, | 2.19665, | 1.94899 |
| 2.60995, | 2.00918, | 1.79609, | 2.03739, | 19.16252, | 40.32675 |
| 61.36478, | 72.61404, | 77.56471, | 78.67237, | 77.97537, | 63.69867 |
| 68.25182, | 63.63826, | 56.36827, | 49.50508, | 43.02991, | 38.74050 |

C GROUP 86 - S1, FWD, PORT, ZENITH

2086= \$ INCIDENT SOLAR FLUX ARRAY - LOCATION - 86

159.34981, 155.75571, 157.10594, 147.41563, 135.63580, 119.89844
119.11469, 117.48251, 95.84847, 67.21191, 5.44292, 2.36513
2.36935, 7.48460, 0.00000, 0.00000, 0.00000, 0.00000
0.00000, 0.00000, 0.00000, 0.00000, 0.00000, 0.00000
0.00000, 0.00000, 0.00000, 0.00000, 0.00000, 0.00000
0.00000, 0.00000, 0.00000, 147.21289, 144.58780, 137.01247
157.16420, 170.43451, 186.61732, 194.70241, 201.36652, 203.99501
205.17271, 195.77429, 187.55440, 171.94762, 169.73322, 166.47691

C GROUP 86 - S1, FWD, PORT, ZENITH

3086= \$ INCIDENT IR FLUX ARRAY - LOCATION - 86

58.02556, 54.65220, 50.64062, 44.44352, 38.58537, 35.81030
30.46541, 30.61370, 30.67323, 28.23722, 33.76152, 20.60685
18.92945, 19.31821, 16.75681, 15.14441, 13.16960, 12.39834
11.70940, 11.56337, 13.82584, 9.63061, 9.07547, 9.09957
8.20019, 7.99933, 7.90775, 9.60113, 7.20077, 6.81813
6.68225, 6.39723, 6.15760, 10.33049, 20.83996, 24.92384
36.58205, 43.50792, 50.51683, 58.83598, 69.49255, 74.24377
79.01746, 78.05500, 78.87187, 75.93498, 74.49121, 70.19163

Appendix K
Sink Temperatures.US5 File (Extract)
Sink Temperatures at Cube Locations (Earth Orbit)

SINK TEMPERATURES FOR: GROUP 152 - SHUTTLE NOSE, BACKSIDE

NUMBER OF MATERIALS = 5

Material 1, Absorptivity = 0.380, Emissivity = 0.830, Ratio (a/e) = 0.4578

Material 2, Absorptivity = 0.580, Emissivity = 0.790, Ratio (a/e) = 0.7342

Material 3, Absorptivity = 0.180, Emissivity = 0.840, Ratio (a/e) = 0.2143

Material 4, Absorptivity = 0.420, Emissivity = 0.110, Ratio (a/e) = 3.8182

Material 5, Absorptivity = 0.070, Emissivity = 0.800, Ratio (a/e) = 0.0875

SINK TEMPERATURES FOR 5 MATERIALS

TIME = HOURS, QSOL AND QIR = BTU/HR/FT**2, TEMP = DEGF

| TIME | QSOL | QIR | TSINK_MAT1 | TSINK_MAT2 | TSINK_MAT3 | TSINK_MAT4 | TSINK_MAT5 |
|----------|-----------|----------|------------|------------|------------|------------|------------|
| 16.93193 | 58.84053 | 34.51741 | -24.73 | 1.57 | -52.69 | 163.75 | -69.86 |
| 16.96386 | 33.03804 | 28.21892 | -61.12 | -41.59 | -81.08 | 87.96 | -92.86 |
| 16.99579 | 31.10059 | 23.47870 | -74.74 | -54.46 | -95.74 | 76.86 | -108.29 |
| 17.02771 | 28.39160 | 20.87336 | -84.96 | -64.91 | -105.77 | 64.20 | -118.24 |
| 17.05964 | 24.62483 | 17.97002 | -98.49 | -79.08 | -118.65 | 45.72 | -130.74 |
| ----- | | | | | | | |
| 18.33679 | 150.30550 | 56.36827 | 59.99 | 98.61 | 16.92 | 318.92 | -11.11 |
| 18.36872 | 144.65431 | 49.50508 | 49.89 | 89.15 | 5.66 | 309.98 | -23.49 |
| 18.40065 | 128.21388 | 43.02991 | 33.71 | 72.01 | -9.53 | 286.81 | -38.10 |
| 18.43258 | 126.04385 | 38.74050 | 27.18 | 66.21 | -17.32 | 282.36 | -47.09 |

SINK TEMPERATURES FOR: GROUP 86 - S1, FWD, PORT, ZENITH

NUMBER OF MATERIALS = 5

Material 1, Absorptivity = 0.380, Emissivity = 0.830, Ratio (a/e) = 0.4578

Material 2, Absorptivity = 0.580, Emissivity = 0.790, Ratio (a/e) = 0.7342

Material 3, Absorptivity = 0.180, Emissivity = 0.840, Ratio (a/e) = 0.2143

Material 4, Absorptivity = 0.420, Emissivity = 0.110, Ratio (a/e) = 3.8182

Material 5, Absorptivity = 0.070, Emissivity = 0.800, Ratio (a/e) = 0.0875

SINK TEMPERATURES FOR 5 MATERIALS

TIME = HOURS, QSOL AND QIR = BTU/HR/FT**2, TEMP = DEGF

| TIME | QSOL | QIR | TSINK_MAT1 | TSINK_MAT2 | TSINK_MAT3 | TSINK_MAT4 | TSINK_MAT5 |
|----------|-----------|----------|------------|------------|------------|------------|------------|
| 16.93193 | 159.34981 | 58.02556 | 65.91 | 105.43 | 21.68 | 329.87 | -7.21 |
| 16.96386 | 155.75571 | 54.65220 | 60.80 | 100.51 | 16.18 | 324.75 | -13.12 |
| 16.99579 | 157.10594 | 50.64062 | 57.26 | 97.99 | 11.06 | 325.10 | -19.63 |
| 17.02771 | 147.41563 | 44.44352 | 45.65 | 86.45 | -0.95 | 311.73 | -32.21 |
| ----- | | | | | | | |
| 18.33679 | 187.55440 | 78.87187 | 96.95 | 136.37 | 53.52 | 365.47 | 25.70 |
| 18.36872 | 171.94762 | 75.93498 | 88.22 | 126.20 | 46.61 | 348.74 | 20.12 |
| 18.40065 | 169.73322 | 74.49121 | 86.03 | 123.96 | 44.44 | 345.99 | 17.94 |
| 18.43258 | 166.47691 | 70.19163 | 80.76 | 118.99 | 38.66 | 341.29 | 11.69 |

Appendix L
SOL IR FLUX ARRAYS.US4 File (Extract)
Solar and IR Fluxes for Cube Locations (Mars Orbit)

EVA START TIME (HOUR) = 16.90000

C TIME ARRAY

1000 =

| | | | | | |
|-----------|-----------|-----------|-----------|-----------|----------|
| 16.94063, | 16.98126, | 17.02190, | 17.06253, | 17.10316, | 17.14379 |
| 17.18442, | 17.22506, | 17.26569, | 17.30632, | 17.34695, | 17.38758 |
| 17.42821, | 17.46885, | 17.50948, | 17.55011, | 17.59074, | 17.63137 |
| 17.67200, | 17.71264, | 17.75327, | 17.79390, | 17.83453, | 17.87517 |
| 17.91580, | 17.95643, | 17.99706, | 18.03769, | 18.07833, | 18.11896 |
| 18.15959, | 18.20022, | 18.24085, | 18.28149, | 18.32212, | 18.36275 |
| 18.40338, | 18.44401, | 18.48464, | 18.52528, | 18.56591, | 18.60654 |
| 18.64717, | 18.68781, | 18.72844, | 18.76907, | 18.80970, | 18.85033 |

C GROUP 152 - SHUTTLE NOSE, BACKSIDE

2152= \$ INCIDENT SOLAR FLUX ARRAY - LOCATION - 152

| | | | | | |
|-----------|-----------|-----------|-----------|-----------|----------|
| 27.18749, | 18.22669, | 16.48882, | 15.55501, | 13.81233, | 12.22219 |
| 10.19243, | 8.15928, | 6.29381, | 3.75585, | 1.63295, | 0.19806 |
| 0.11043, | 0.00898, | 0.00000, | 0.00000, | 0.00000, | 0.00000 |
| 0.00000, | 0.00000, | 0.00000, | 0.00000, | 0.00000, | 0.00000 |
| 0.00000, | 0.00000, | 0.00000, | 0.00000, | 0.00000, | 0.00000 |
| 0.00000, | 0.00000, | 58.34755, | 58.23627, | 52.99983, | 51.43205 |
| 58.58344, | 62.48112, | 66.83106, | 66.74606, | 71.74096, | 71.40333 |
| 74.79694, | 71.75675, | 68.63168, | 64.55531, | 57.75021, | 59.71589 |

C GROUP 152 - SHUTTLE NOSE, BACKSIDE

3152= \$ INCIDENT IR FLUX ARRAY - LOCATION - 152

| | | | | | |
|-----------|-----------|-----------|-----------|-----------|----------|
| 26.73363, | 20.35606, | 16.60342, | 13.81823, | 12.12746, | 10.64113 |
| 9.45097, | 8.64302, | 7.84626, | 7.45662, | 6.49912, | 5.90752 |
| 5.34595, | 4.61285, | 4.28150, | 4.12521, | 3.28190, | 2.87359 |
| 2.74381, | 2.54470, | 2.42093, | 2.32410, | 2.17180, | 2.02040 |
| 1.99189, | 1.90015, | 1.67314, | 1.61451, | 1.61691, | 1.47999 |
| 1.35165, | 1.29657, | 2.11075, | 6.11072, | 11.47843, | 17.49724 |
| 22.22339, | 28.11276, | 30.49962, | 31.87427, | 32.24025, | 31.48911 |
| 29.88280, | 28.28738, | 25.78642, | 23.32155, | 20.81808, | 18.24977 |

C GROUP 86 - S1, FWD, PORT, ZENITH

2086= \$ INCIDENT SOLAR FLUX ARRAY - LOCATION - 86

| | | | | | |
|-----------|-----------|-----------|-----------|-----------|----------|
| 69.20858, | 69.70843, | 66.03600, | 61.40901, | 56.16034, | 52.32261 |
| 49.62833, | 49.00669, | 40.87474, | 25.94955, | 1.63729, | 3.32932 |
| 2.32168, | 2.78006, | 1.56671, | 0.00000, | 0.00000, | 0.00000 |
| 0.00000, | 0.00000, | 0.00000, | 0.00000, | 0.00000, | 0.00000 |
| 0.00000, | 0.00000, | 0.00000, | 0.00000, | 0.00000, | 0.00000 |
| 0.00000, | 0.00000, | 58.12986, | 62.62794, | 62.58204, | 62.15215 |
| 67.82761, | 74.42306, | 77.66618, | 81.09560, | 85.26012, | 85.01486 |
| 83.43905, | 84.52227, | 80.36153, | 78.54178, | 69.57850, | 68.31884 |

C GROUP 86 - S1, FWD, PORT, ZENITH

3086= \$ INCIDENT IR FLUX ARRAY - LOCATION - 86

| | | | | | |
|-----------|-----------|-----------|-----------|-----------|----------|
| 41.12463, | 35.71749, | 32.35229, | 28.48830, | 24.94860, | 21.17259 |
| 19.76263, | 17.85165, | 17.25076, | 16.88623, | 16.32371, | 13.94970 |
| 11.85371, | 11.47170, | 11.44193, | 10.13142, | 9.09880, | 11.38572 |
| 7.69332, | 7.48395, | 7.67403, | 7.14028, | 7.02660, | 6.40268 |
| 6.35738, | 5.91556, | 5.39463, | 5.46212, | 5.86401, | 5.06813 |
| 4.67566, | 4.50626, | 6.09519, | 10.00965, | 13.78979, | 12.12127 |
| 14.49305, | 18.61273, | 22.72001, | 24.96985, | 27.62862, | 30.03171 |
| 32.07136, | 31.50132, | 33.18785, | 31.92125, | 32.13807, | 30.73942 |

Appendix M
Sink Temperatures.US5 File (Extract)
Sink Temperatures at Cube Locations (Mars Orbit)

SINK TEMPERATURES FOR: GROUP 152 - SHUTTLE NOSE, BACKSIDE

NUMBER OF MATERIALS = 5

Material 1, Absorptivity = 0.380, Emissivity = 0.830, Ratio (a/e) = 0.4578
 Material 2, Absorptivity = 0.580, Emissivity = 0.790, Ratio (a/e) = 0.7342
 Material 3, Absorptivity = 0.180, Emissivity = 0.840, Ratio (a/e) = 0.2143
 Material 4, Absorptivity = 0.420, Emissivity = 0.110, Ratio (a/e) = 3.8182
 Material 5, Absorptivity = 0.070, Emissivity = 0.800, Ratio (a/e) = 0.0875

SINK TEMPERATURES FOR 5 MATERIALS

TIME = HOURS, QSOL AND QIR = BTU/HR/FT**2, TEMP = DEGF

| TIME | QSOL | QIR | TSINK_MAT1 | TSINK_MAT2 | TSINK_MAT3 | TSINK_MAT4 | TSINK_MAT5 |
|----------|----------|----------|------------|------------|------------|------------|------------|
| 16.94063 | 27.18749 | 26.73363 | -71.06 | -53.62 | -88.65 | 65.47 | -98.90 |
| 16.98126 | 18.22669 | 20.35606 | -100.18 | -85.34 | -114.98 | 18.75 | -123.51 |
| 17.02190 | 16.48882 | 16.60342 | -115.37 | -100.15 | -130.69 | 4.29 | -139.59 |
| 17.06253 | 15.55501 | 13.81823 | -127.45 | -111.56 | -143.64 | -5.27 | -153.15 |
| ----- | | | | | | | |
| 18.72844 | 68.63168 | 25.78642 | -32.46 | -0.73 | -67.84 | 180.32 | -90.86 |
| 18.76907 | 64.55531 | 23.32155 | -40.79 | -9.19 | -76.19 | 170.05 | -99.34 |
| 18.80970 | 57.75021 | 20.81808 | -52.40 | -21.65 | -86.86 | 152.72 | -109.40 |
| 18.85033 | 59.71589 | 18.24977 | -56.05 | -23.61 | -93.04 | 155.83 | -117.81 |

SINK TEMPERATURES FOR: GROUP 86 - S1, FWD, PORT, ZENITH

NUMBER OF MATERIALS = 5

Material 1, Absorptivity = 0.380, Emissivity = 0.830, Ratio (a/e) = 0.4578
 Material 2, Absorptivity = 0.580, Emissivity = 0.790, Ratio (a/e) = 0.7342
 Material 3, Absorptivity = 0.180, Emissivity = 0.840, Ratio (a/e) = 0.2143
 Material 4, Absorptivity = 0.420, Emissivity = 0.110, Ratio (a/e) = 3.8182
 Material 5, Absorptivity = 0.070, Emissivity = 0.800, Ratio (a/e) = 0.0875

SINK TEMPERATURES FOR 5 MATERIALS

TIME = HOURS, QSOL AND QIR = BTU/HR/FT**2, TEMP = DEGF

| TIME | QSOL | QIR | TSINK_MAT1 | TSINK_MAT2 | TSINK_MAT3 | TSINK_MAT4 | TSINK_MAT5 |
|----------|----------|----------|------------|------------|------------|------------|------------|
| 16.94063 | 69.20858 | 41.12463 | -5.89 | 21.38 | -34.82 | 189.86 | -52.57 |
| 16.98126 | 69.70843 | 35.71749 | -14.19 | 14.64 | -45.27 | 187.99 | -64.68 |
| 17.02190 | 66.03600 | 32.35229 | -22.75 | 6.13 | -54.04 | 178.45 | -73.69 |
| 17.06253 | 61.40901 | 28.48830 | -33.59 | -4.71 | -65.08 | 166.01 | -84.99 |
| ----- | | | | | | | |
| 18.72844 | 80.36153 | 33.18785 | -10.37 | 21.70 | -45.77 | 207.56 | -68.51 |
| 18.76907 | 78.54178 | 31.92125 | -13.78 | 18.27 | -49.22 | 203.49 | -72.03 |
| 18.80970 | 69.57850 | 32.13807 | -20.31 | 9.54 | -52.86 | 185.79 | -73.45 |
| 18.85033 | 68.31884 | 30.73942 | -23.74 | 6.23 | -56.52 | 182.40 | -77.32 |